





DESIGN NUMBER	330130-001	
CLASS	23-02	
OK PLAY HEALTHCARE PRIVATE LIMITED, 124, NEW MANGLAPURI, MEHRAULI, DELHI-110030		
DATE OF REGISTRATION	17/06/2020	
TITLE	HAND WASH BASIN	
PRIORITY NA		
DESIGN NUMBER	330167-001	
CLASS	29-02	
1.DR.P.SATISH KUMAR, ASSOCIATE PROFESSOR, UNIVERSITY COLLEGE OF ENGINEERING, OSMANIA UNIVERSITY, HYDERABAD, TELANGANA INDIA 500034 2. DR.SHAIK MAHABOOB, MUFAKHAM JAH COLLEGE OF ENGINEERING & TECHNOLOGY, 8-2-249 TO 267, ROAD NUMBER 3 MOUNT PLEASANT, BANJARA HILLS, HYDERABAD, TELANGANA 3. DR.AKASH KUMAR BHOI, R&D FACULTY ASSOCIATE, ASSISTANT PROFESSOR DEPARTMENT OF ELECTRICAL & ELECTRONICS ENGINEERING, SIKKIM MANIPAL INSTITUTE OF TECHNOLOGY (SMIT), MAJITAR, EAST SIKKIM - , SIKKIM, INDIA 4. ARSHAD MOHAMMED, MUFAKHAM JAH COLLEGE OF ENGINEERING & TECHNOLOGY, 8-2-249 TO 267, ROAD NUMBER 3 MOUNT PLEASANT, BANJARA HILLS, HYDERABAD, TELANGANA 500034		
DATE OF REGISTRATION	18/06/2020	
TITLE	SMART SELF DISINFECTING FACE SHIELD	
PRIORITY NA		
DESIGN NUMBER	330537-001	
CLASS	12-08	
CENTURION UNIVERSITY OF TECHNOLOGY & MANAGEMENT (CUTM), AT-ALLURI NAGAR, PO-R.SITAPUR, VIA-UPPALADA, PARLAKHEMUNDI-761211, GAJAPATI DIST, ODISHA, INDIA		
DATE OF REGISTRATION	29/06/2020	
TITLE	COMPACT COMMERCIAL ELECTRIC VEHICLE	
PRIORITY NA		

DESIGN NUMBER	322906-001		
CLASS	14-03		
BEIJING XIAOMI MOBILE SOFTWARE CO., LTD., ROOM 01, FLOOR 9, RAINBOW CITY SHOPPING MALL II OF CHINA RESOURCES, NO. 68, QINGHE MIDDLE STREET, HAIDIAN DISTRICT, BEIJING 100085, CHINA			
DATE OF REGISTRATION	23/10/2019		
TITLE	MOBILE PHONE		
PRIORITY			
PRIORITY NUMBER	DATE	COUNTRY	
201930196200.2	25/04/2019	CHINA	
DESIGN NUMBER	330538-001		
CLASS	12-11		
CENTURION UNIVERSITY OF TECHNOLOGY & MANAGEMENT (CUTM), AT-ALLURI NAGAR, PO-R.SITAPUR, VIA-UPPALADA, PARLAKHEMUNDI-761211, GAJAPATI DIST., ODISHA, INDIA			
DATE OF REGISTRATION	29/06/2020		
TITLE	ELECTRIC BIKE		
PRIORITY NA			
DESIGN NUMBER	330559-001		
CLASS	16-02		
SAMSUNG ELECTRONICS CO., LTD, 129, SAMSUNG-RO, YEONGTONG-GU, SUWON-SI, GYEONGGI-DO, REPUBLIC OF KOREA			
DATE OF REGISTRATION	30/06/2020		
TITLE	BEAM PROJECTOR		
PRIORITY			
PRIORITY NUMBER	DATE	COUNTRY	
30-2020-0000250	03/01/2020	REPUBLIC OF KOREA	

Design Application Details

Application Number:

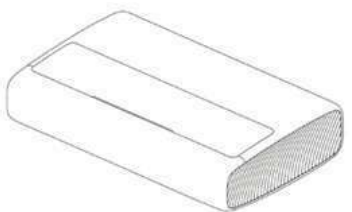
348484-001

Cbr Number:

206829

Cbr Date:

27/08/2021 08:27:03

Applicant Name:

1. Centurion University of technology and management 2. Tapan kumar padhy
3. Hariharan Nelli 4. Dinesh tej kovelakonda 5. Suman Kumar Sudhanshu

Design Application Status

Application Status:

Design Accepted and Published, Journal No is 02/2023 and Journal Date is 13/01/2023

[Back \(/DesignApplicationStatus/\)](#)

Disclaimer: Application status is available for the application filed on or after 1st April 2009 with application no 222230. The information under " Design Application Status" is dynamically retrieved and is under testing, therefore the information retrieved by this system is not valid for any legal proceedings under the Design Act 2000. In case of any discrepancy you may contact the appropriate Patent Office or send your comments to following email IDs:

Design Office, Kolkata : controllerdesign.ipo@nic.in

Controller General of Patents, Designs and Trademarks

Design Application Details

Application Number:

348485-001

Cbr Number:

206829

Cbr Date:

27/08/2021 08:27:03

Applicant Name:

1. Centurion University of Technology and Management 2. Tapan kumar padhy
3. Hariharan Nelli 4. Dinesh Tej Kovelakonda 5. Suman Kumar Sudhanshu

Design Application Status

Application Status:

Design Accepted and Published, Journal No is 09/2023 and Journal Date is 03/03/2023

[Back \(/DesignApplicationStatus/\)](#)

Disclaimer: Application status is available for the application filed on or after 1st April 2009 with application no 222230. The information under " Design Application Status" is dynamically retrieved and is under testing, therefore the information retrieved by this system is not valid for any legal proceedings under the Design Act 2000. In case of any discrepancy you may contact the appropriate Patent Office or send your comments to following email IDs:

Design Office, Kolkata : controllerdesign.ipo@nic.in

Controller General of Patents, Designs and Trademarks

Design Application Details

Application Number:

348487-001

Cbr Number:

206829

Cbr Date:

27/08/2021 08:27:03

Applicant Name:

1. Centurion University of Technology and Management 2. Tapan Kumar Padhy
3. Hariharan Nelli 4. Dinesh Tej Kovelakonda 5. Suman Kumar Sudhanshu

Design Application Status

Application Status:

Design Accepted and Published, Journal No is 02/2023 and Journal Date is 13/01/2023

[Back \(/DesignApplicationStatus/\)](#)

Disclaimer: Application status is available for the application filed on or after 1st April 2009 with application no 222230. The information under " Design Application Status" is dynamically retrieved and is under testing, therefore the information retrieved by this system is not valid for any legal proceedings under the Design Act 2000. In case of any discrepancy you may contact the appropriate Patent Office or send your comments to following email IDs:

Design Office, Kolkata : controllerdesign.ipo@nic.in

Controller General of Patents, Designs and Trademarks

Design Application Details

Application Number:

348489-001

Cbr Number:

206829

Cbr Date:

27/08/2021 08:27:03

Applicant Name:

1. Centurion University of Technology and Management 2. Tapan Kumar Padhy
3. Hariharan Nelli 4. Dinesh Tej Kovelakonda 5. Suman Kumar Sudhanshu

Design Application Status

Application Status:

Design Accepted and Published, Journal No is 01/2023 and Journal Date is 06/01/2023

[Back \(/DesignApplicationStatus/\)](#)

Disclaimer: Application status is available for the application filed on or after 1st April 2009 with application no 222230. The information under " Design Application Status" is dynamically retrieved and is under testing, therefore the information retrieved by this system is not valid for any legal proceedings under the Design Act 2000. In case of any discrepancy you may contact the appropriate Patent Office or send your comments to following email IDs:

Design Office, Kolkata : controllerdesign.ipo@nic.in

Controller General of Patents, Designs and Trademarks

Design Application Details

Application Number:

348490-001

Cbr Number:

206829

Cbr Date:

27/08/2021 08:27:03

Applicant Name:

1. Centurion University of Technology and Management 2. Tapan Kumar Padhy
3. Hariharan Nelli 4. Dinesh Tej Kovelakonda 5. Suman Kumar Sudhanshu

Design Application Status

Application Status:



Design Accepted and Published, Journal No is 08/2023 and Journal Date is 24/02/2023

[Back \(/DesignApplicationStatus/\)](#)

Disclaimer: Application status is available for the application filed on or after 1st April 2009 with application no 222230. The information under " Design Application Status" is dynamically retrieved and is under testing, therefore the information retrieved by this system is not valid for any legal proceedings under the Design Act 2000. In case of any discrepancy you may contact the appropriate Patent Office or send your comments to following email IDs:

Design Office, Kolkata : controllerdesign.ipo@nic.in

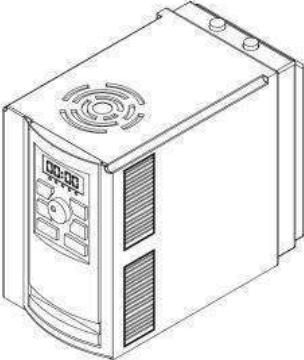
Controller General of Patents, Designs and Trademarks

Design Number	375060-001	
Class	26-05	
M/S EVERSHINE STAGE LIGHTS AND EQUIPMENTS M/S EVERSHINE STAGE LIGHTS AND EQUIPMENTS, FLOOR 1ST, 5073/11, JAPANI BUILDING, SUBZI MANDI LANDMARK, OPP ROSHANARA PARK AND GARDEN, ROSHANARA ROAD, NORTH DELHI, DELHI-110007		
Date of Registration	05/12/2022	
Title	LED PAR LIGHT HOUSING	
Priority NA		
Design Number	375062-001	
Class	13-02	
1.Dr.Sushil Kumar Bhoi Assistant Professor, Department of Electrical Engineering, Government College of Engineering Kalahandi, Bhawanipatna, Odisha, India. Pin Code:766003 2. Dr.Asini Kumar Baliarsingh Associate Professor, Department of Electrical Engineering, Government College of Engineering Kalahandi, Bhawanipatna, Odisha, India. Pin Code:766003 3. Dr.Deepa Das Assistant Professor, Department of Electronics and Telecommunication Engineering, Government College of Engineering Kalahandi, Bhawanipatna, Odisha, India. Pin Code:766003 4. Dr.Ashish Kumar Sarangi Assistant Professor, Department of Chemistry, School of Applied Science, Centurion University of Technology and Management, Balangir, Odisha, India. Pin Code:767001		
Date of Registration	05/12/2022	
Title	Frequency Converter Unit	
Priority NA		
Design Number	375067-001	
Class	02-02	
SABYASACHI CALCUTTA LLP 80/2 Topsia Road (South), Kolkata-700046, West Bengal.		
Date of Registration	05/12/2022	
Title	LADIES GARMENT	
Priority NA		

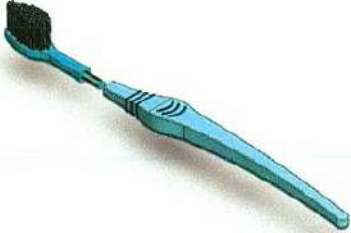
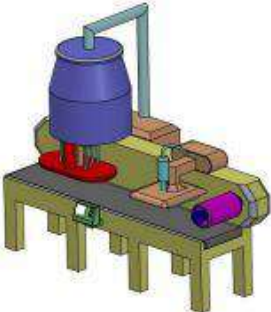
Design Number	370586-001	
Class	04-02	
1. RITU MAITY RITU MAITY, CENTRAL TOOL ROOM & TRAINING CENTRE, B-36, CHANDAKA INDUSTRIAL AREA, PATIA, NEAR INFOCITY SQUARE, BHUBANESWAR-751024, DIST-KHORDHA, ODISHA 2. SHIV SHANKAR KUMAR PRASAD SHIV SHANKAR KUMAR PRASAD, CENTRAL TOOL ROOM & TRAINING CENTRE, B-36, CHANDAKA INDUSTRIAL AREA, PATIA, NEAR INFOCITY SQUARE, BHUBANESWAR-751024, DIST-KHORDHA, ODISHA		
Date of Registration	09/09/2022	
Title	DETACHABLE TOOTHBRUSH	
Priority NA		
Design Number	372607-001	
Class	16-06	
1. Dr. Preetam Suman VIT Bhopal University, Indore Road, Bhopal, Madhya Pradesh 466114, India 2. Dr. Varshali Jaiswal VIT Bhopal University, Indore Road, Bhopal, Madhya Pradesh 466114, India 3. Dr. S. Poonkuntran VIT Bhopal University, Indore Road, Bhopal, Madhya Pradesh 466114, India 4. Dr. Rajit Nair VIT Bhopal University, Indore Road, Bhopal, Madhya Pradesh 466114, India		
Date of Registration	15/10/2022	
Title	SMART SPECTACLE FOR VISUALLY CHALLENGED PERSONS	
Priority NA		
Design Number	372612-001	
Class	15-10	
1. Dr. S. Sivaprasad Associate Professor, Department of Pharmaceutics, MNR College of Pharmacy, MNR Nagar, Narsapur Road, Sangareddy-502294. 2. Dr. Nihar Ranjan Kar Assistant Professor, School of Pharmacy. Centurion University of Technology and Management, Paikasta, Gopalpur, Balasore, Odisha. 3. Dr. Rasapelly Ramesh Kumar Associate Professor, Department of, Pharmaceutical Chemistry, Marri Laxman Reddy Institute of Pharmacy, Dundigal (M), Medchal (D) Hyderabad -500043 4. Alapati Sahithi Assistant Professor, Department of, Pharmaceutical Analysis, Nalla Narasimha Reddy Education Society's Group of Institutions, Via Narapally, Ghatkesar Mandal, Korremula Rd, Hyderabad, Telangana 500088		
Date of Registration	15/10/2022	
Title	BLISTER PACKAGING MACHINE FOR PHARMACEUTICAL PURPOSE	
Priority NA		



ORIGINAL

मूल/No : 124911



भारत सरकार
GOVERNMENT OF INDIA
पेटेंट कार्यालय
THE PATENT OFFICE

डिजाइन के पंजीकरण का प्रमाणपत्र
CERTIFICATE OF REGISTRATION OF DESIGN

डिजाइन सं. / Design No. : 372612-001
तारीख / Date : 15/10/2022
पारस्परिकता तारीख / Reciprocity Date* :
देश / Country :

प्रमाणित किया जाता है कि संलग्न प्रति में वर्णित डिजाइन जो **BLISTER PACKAGING MACHINE FOR PHARMACEUTICAL PURPOSE** से संबंधित है, का पंजीकरण, श्रेणी 15-10 में 1.Dr. S. Sivaprasad 2. Dr. Nihar Ranjan Kar 3.Dr.Rasapelly Ramesh Kumar 4.Alapati Sahithi के नाम में उपर्युक्त संख्या और तारीख में कर लिया गया है।

Certified that the design of which a copy is annexed hereto has been registered as of the number and date given above in class 15-10 in respect of the application of such design to **BLISTER PACKAGING MACHINE FOR PHARMACEUTICAL PURPOSE** in the name of 1.Dr. S. Sivaprasad 2. Dr. Nihar Ranjan Kar 3.Dr.Rasapelly Ramesh Kumar 4.Alapati Sahithi.

डिजाइन अधिनियम, 2000 तथा डिजाइन नियम, 2001 के अध्याधीन प्रावधानों के अनुसरण में।

In pursuance of and subject to the provisions of the Designs Act, 2000 and the Designs Rules, 2001.

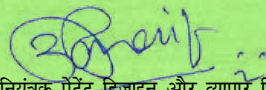

INTELLECTUAL
PROPERTY INDIA
PATENTS | DESIGNS | TRADE MARKS
GEOGRAPHICAL INDICATIONS

निर्गमन की तारीख/Date of Issue : 12/01/2023

महानियंत्रक पेटेंट डिजाइन और व्यापार चिह्न
Controller General of Patents, Designs and Trade Marks

पारस्परिकता तारीख (यदि कोई हो) जिसकी अनुमति देश के नाम पर की गई है। डिजाइन का सत्त्वाधिकार पंजीकरण की तारीख से दस वर्षों के लिए होगा जिसका विस्तार, अधिनियम एवं नियम के निबंधनों के अधीन, पाँच वर्षों की अतिरिक्त अवधि के लिए किया जा सकेगा। इस प्रमाण पत्र का उपयोग विधिक कार्यवाहियों अथवा विदेश में पंजीकरण प्राप्त करने के लिए नहीं हो सकता है।

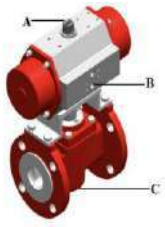
*The reciprocity date (if any) which has been allowed and the name of the country. Copyright in the design will subsist for ten years from the date of Registration, and may under the terms of the Act and Rules, be extended for a further period of five years. This Certificate is not for use in legal proceedings or for obtaining registration abroad.

Design Number	377838-001	
Class	23-01	
UNIFLOW CONTROLS PRIVATE LIMITED Q 49/149, JAI MATA DI COMPOUND, THANE- BHIWANDI AGRA ROAD, KALHER VILLAGE, BHIWANDI, DIST. THANE-421302, MAHARASHTRA, INDIA.		
Date of Registration	23/01/2023	
Title	V-NOTCH BALL VALVE	
Priority NA		
Design Number	377840-001	
Class	23-01	
UNIFLOW CONTROLS PRIVATE LIMITED Q 49/149, JAI MATA DI COMPOUND, THANE- BHIWANDI AGRA ROAD, KALHER VILLAGE, BHIWANDI, DIST. THANE-421302, MAHARASHTRA, INDIA.		
Date of Registration	23/01/2023	
Title	LINED PLUG VALVE	
Priority NA		
Design Number	377851-001	
Class	09-09	
1. Dr. Tridibesh Nag Associate Professor & HOD, Department of Electrical Engineering, Netaji Subhash Engineering College, Techno City, Garia, West Bengal, Kolkata - 700152 2. Dr. Subrata Biswas Associate Professor, Department of Electrical Engineering, Netaji Subhash Engineering College, Techno City, Garia, West Bengal, Kolkata - 700152 3. Mr. Silpi Bose Assistant Professor, Department of Computer Science and Engineering, Netaji Subhash Engineering College, Techno City, Garia, West Bengal, Kolkata - 700152 4. Dr. Prafulla Kumar Panda Associate Professor & HOD, Department of Civil Engineering, Centurion University of Technology and Management, R.Sitapur, Odisha- 761211 , et al.		
Date of Registration	23/01/2023	
Title	IOT BASED FOOD WASTE RECYCLING MACHINE	
Priority NA		



Controller General of Patents, Designs and Trademarks
Department of Industrial Policy and Promotion
Ministry of Commerce and Industry

Design Application Details



Application Number: 376914-001
Cbr Number: 200329
Cbr Date: 07/01/2023 05:45:00
Applicant Name:

1. Dr. Debani Prasad Mishra
2. Dr. Arun Kumar Sahoo
3. Dr. Ramesh Chandra Mohanty
4. Prof. Nimay Chandra Giri

Design Application Status

Application Status: Design Accepted and Published, Journal No is 11/2023 and Journal Date is 17/03/2023

[Back](#)

Design Number	377766-001		
Class	12-16		
Premier Seals (India) Pvt Ltd 20/8, D1 Block, MIDC Chinchwad, Pune-411019, Maharashtra, India.			
Date of Registration	21/01/2023		
Title	SWITCHABLE TORQUE ROD		
Priority NA			
Design Number	377789-001		
Class	09-01		
Dart Industries Inc. 14901 S. Orange Blossom Trail, Orlando, Florida 32837, U.S.A.			
Date of Registration	21/01/2023		
Title	Drinking Tumbler with Cover		
Priority			
Priority Number	Date	Country	
29/851,370	27/08/2022	U.S.A.	
Design Number	377791-001		
Class	15-09		
1.Dr.BIJAYA BIJETA NAYAK Assistant Professor, School of Mechanical Engineering, KIIT Deemed to be University, KIIT Road, Patia, Bhubaneswar, Odisha- 751024, India. 2. Dr.SASMITA SAHU Assistant Professor, School of Mechanical Engineering, KIIT Deemed to be University, KIIT Road, Patia, Bhubaneswar, Odisha- 751024, India. 3. Dr. SANTOSH KUMAR NAYAK Associate Professor, School of Mechanical Engineering, KIIT Deemed to be University, KIIT Road, Patia, Bhubaneswar, Odisha- 751024, India. 4. Ms. DEBASHREE DEBADATTA BEHERA Assistant Professor, Mechanical Engineering Department, Centurion University of Technology and Management, Odisha-761211, India. , et al.			
Date of Registration	21/01/2023		
Title	POWDER MANUFACTURING UNIT		
Priority NA			



ORIGINAL

मूल/No : 131380



भारत सरकार
GOVERNMENT OF INDIA
पेटेंट कार्यालय
THE PATENT OFFICE

डिजाइन के पंजीकरण का प्रमाणपत्र
CERTIFICATE OF REGISTRATION OF DESIGN

डिजाइन सं. / Design No. : 376903-001
तारीख / Date : 07/01/2023
पारस्परिकता तारीख / Reciprocity Date* :
देश / Country :

प्रमाणित किया जाता है कि संलग्न प्रति में वर्णित डिजाइन जो **IOT BASED AGRICULTURE ROBOT FOR PESTICIDES SPRAYING** से संबंधित है, का पंजीकरण, श्रेणी 15-03 में 1.Prof. Prasheet Mishra 2. Dr.Taraprasad Mohapatra 3.Prof.Sudhansu Sekhar Mishra 4.Prof. Nimay Chandra Giri के नाम में उपर्युक्त संख्या और तारीख में कर लिया गया है।

Certified that the design of which a copy is annexed hereto has been registered as of the number and date given above in class 15-03 in respect of the application of such design to **IOT BASED AGRICULTURE ROBOT FOR PESTICIDES SPRAYING** in the name of 1.Prof. Prasheet Mishra 2. Dr.Taraprasad Mohapatra 3.Prof.Sudhansu Sekhar Mishra 4.Prof. Nimay Chandra Giri.

डिजाइन अधिनियम, 2000 तथा डिजाइन नियम, 2001 के अध्याधीन प्रावधानों के अनुसरण में।

In pursuance of and subject to the provisions of the Designs Act, 2000 and the Designs Rules, 2001.

INTELLECTUAL
PROPERTY INDIA
PATENTS | DESIGNS | TRADE MARKS
GEOGRAPHICAL INDICATIONS

निर्गमन की तारीख/Date of Issue : 20/03/2023

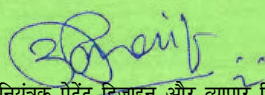
महानियंत्रक पेटेंट डिजाइन और व्यापार चिह्न
Controller General of Patents, Designs and Trade Marks

पारस्परिकता तारीख (यदि कोई हो) जिसकी अनुमति देश के नाम पर की गई है। डिजाइन का सत्त्वाधिकार पंजीकरण की तारीख से दस वर्षों के लिए होगा जिसका विस्तार, अधिनियम एवं नियम के निबंधनों के अधीन, पाँच वर्षों की अतिरिक्त अवधि के लिए किया जा सकेगा। इस प्रमाण पत्र का उपयोग विधिक कार्यवाहियों अथवा विदेश में पंजीकरण प्राप्त करने के लिए नहीं हो सकता है।

*The reciprocity date (if any) which has been allowed and the name of the country. Copyright in the design will subsist for ten years from the date of Registration, and may under the terms of the Act and Rules, be extended for a further period of five years. This Certificate is not for use in legal proceedings or for obtaining registration abroad.



ORIGINAL

मूल/No : 131381



भारत सरकार
GOVERNMENT OF INDIA
पेटेंट कार्यालय
THE PATENT OFFICE

डिजाइन के पंजीकरण का प्रमाणपत्र
CERTIFICATE OF REGISTRATION OF DESIGN

डिजाइन सं. / Design No. : 376944-001
तारीख / Date : 07/01/2023
पारस्परिकता तारीख / Reciprocity Date* :
देश / Country :

प्रमाणित किया जाता है कि संलग्न प्रति में वर्णित डिजाइन जो **IOT BASED CAMERA FOR HEALTHCARE MANAGEMENT** से संबंधित है, का पंजीकरण, श्रेणी **16-01** में 1.Prof. Sima Das 2. Prof. Susmita Chakrabarty 3.Ms. Solanki Mitra 4.Prof. Nimay Chandra Giri के नाम में उपर्युक्त संख्या और तारीख में कर लिया गया है।

Certified that the design of which a copy is annexed hereto has been registered as of the number and date given above in class **16-01** in respect of the application of such design to **IOT BASED CAMERA FOR HEALTHCARE MANAGEMENT** in the name of 1.Prof. Sima Das 2. Prof. Susmita Chakrabarty 3.Ms. Solanki Mitra 4.Prof. Nimay Chandra Giri.

डिजाइन अधिनियम, 2000 तथा डिजाइन नियम, 2001 के अध्याधीन प्रावधानों के अनुसरण में।

In pursuance of and subject to the provisions of the Designs Act, 2000 and the Designs Rules, 2001.

INTELLECTUAL
PROPERTY INDIA
PATENTS | DESIGNS | TRADE MARKS
GEOGRAPHICAL INDICATIONS

निर्गमन की तारीख/Date of Issue : 20/03/2023

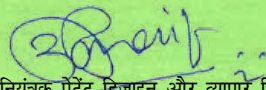
महानियंत्रक पेटेंट डिजाइन और व्यापार चिह्न
Controller General of Patents, Designs and Trade Marks

पारस्परिकता तारीख (यदि कोई हो) जिसकी अनुमति देश के नाम पर की गई है। डिजाइन का सत्त्वाधिकार पंजीकरण की तारीख से दस वर्षों के लिए होगा जिसका विस्तार, अधिनियम एवं नियम के निबंधनों के अधीन, पाँच वर्षों की अतिरिक्त अवधि के लिए किया जा सकेगा। इस प्रमाण पत्र का उपयोग विधिक कार्यवाहियों अथवा विदेश में पंजीकरण प्राप्त करने के लिए नहीं हो सकता है।

*The reciprocity date (if any) which has been allowed and the name of the country. Copyright in the design will subsist for ten years from the date of Registration, and may under the terms of the Act and Rules, be extended for a further period of five years. This Certificate is not for use in legal proceedings or for obtaining registration abroad.



ORIGINAL

मूल/No : 132036



भारत सरकार
GOVERNMENT OF INDIA
पेटेंट कार्यालय
THE PATENT OFFICE
डिजाइन के पंजीकरण का प्रमाणपत्र
CERTIFICATE OF REGISTRATION OF DESIGN

डिजाइन सं. / Design No. : 357339-001
तारीख / Date : 26/01/2022
पारस्परिकता तारीख / Reciprocity Date* :
देश / Country :

प्रमाणित किया जाता है कि संलग्न प्रति में वर्णित डिजाइन जो **E-RICKSHAW** से संबंधित है, का पंजीकरण, श्रेणी **12-11** में 1.Centurion University Of Technology & Management (Cutm) 2. N.Laxmidhar Reddy 3.Sipalin Nayak के नाम में उपर्युक्त संख्या और तारीख में कर लिया गया है।

Certified that the design of which a copy is annexed hereto has been registered as of the number and date given above in class **12-11** in respect of the application of such design to **E-RICKSHAW** in the name of 1.Centurion University Of Technology & Management (Cutm) 2. N.Laxmidhar Reddy 3.Sipalin Nayak.

डिजाइन अधिनियम, 2000 तथा डिजाइन नियम, 2001 के अध्याधीन प्रावधानों के अनुसरण में।

In pursuance of and subject to the provisions of the Designs Act, 2000 and the Designs Rules, 2001.

INTELLECTUAL
PROPERTY INDIA
PATENTS | DESIGNS | TRADE MARKS
GEOGRAPHICAL INDICATIONS

निर्गमन की तारीख/Date of Issue : 28/03/2023

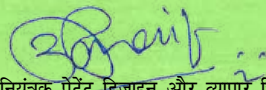
महानियंत्रक पेटेंट डिजाइन और व्यापार चिह्न
Controller General of Patents, Designs and Trade Marks

पारस्परिकता तारीख (यदि कोई हो) जिसकी अनुमति देश के नाम पर की गई है। डिजाइन का सत्त्वाधिकार पंजीकरण की तारीख से दस वर्षों के लिए होगा जिसका विस्तार, अधिनियम एवं नियम के निबंधनों के अधीन, पाँच वर्षों की अतिरिक्त अवधि के लिए किया जा सकेगा। इस प्रमाण पत्र का उपयोग विधिक कार्यवाहियों अथवा विदेश में पंजीकरण प्राप्त करने के लिए नहीं हो सकता है।

*The reciprocity date (if any) which has been allowed and the name of the country. Copyright in the design will subsist for ten years from the date of Registration, and may under the terms of the Act and Rules, be extended for a further period of five years. This Certificate is not for use in legal proceedings or for obtaining registration abroad.

Design Application Details

Application Number:	346872-001
Cbr Number:	205695
Cbr Date:	28/07/2021 09:09:37
Applicant Name:	<ol style="list-style-type: none">1. Centurion University of Technology & Management (CUTM)2. Dr.Nitesh Dhar Badgayan3. Mr.E.Krushna Murty4. Mr.Jitendra Pramanik

Design Application Status

Application Status: Design Accepted and Published, Journal No is 52/2022 and Journal Date is 30/12/2022

[Back](#)



ORIGINAL

मूल/No : 133388



भारत सरकार
GOVERNMENT OF INDIA
पेटेंट कार्यालय
THE PATENT OFFICE

डिजाइन के पंजीकरण का प्रमाणपत्र
CERTIFICATE OF REGISTRATION OF DESIGN

डिजाइन सं. / Design No. : 368071-001
तारीख / Date : 20/07/2022
पारस्परिकता तारीख / Reciprocity Date* :
देश / Country :

प्रमाणित किया जाता है कि संलग्न प्रति में वर्णित डिजाइन जो **SOLAR OPTICAL DESALINATION UNIT** से संबंधित है, का पंजीकरण, श्रेणी **23-03** में 1.Dr. Bijaya Bijeta Nayak 2. Dr. Shiv Sankar Das 3.Ms. Debashree Debadatta Behera 4.Mr. Soumya Ranjan Giri के नाम में उपर्युक्त संख्या और तारीख में कर लिया गया है।

Certified that the design of which a copy is annexed hereto has been registered as of the number and date given above in class **23-03** in respect of the application of such design to **SOLAR OPTICAL DESALINATION UNIT** in the name of 1.Dr. Bijaya Bijeta Nayak 2. Dr. Shiv Sankar Das 3.Ms. Debashree Debadatta Behera 4.Mr. Soumya Ranjan Giri.

डिजाइन अधिनियम, 2000 तथा डिजाइन नियम, 2001 के अध्याधीन प्रावधानों के अनुसरण में।

In pursuance of and subject to the provisions of the Designs Act, 2000 and the Designs Rules, 2001.

INTELLECTUAL
PROPERTY INDIA
PATENTS | DESIGNS | TRADE MARKS
GEOGRAPHICAL INDICATIONS

निर्गमन की तारीख/Date of Issue : 19/04/2023

महानियंत्रक पेटेंट-डिजाइन और व्यापार चिह्न
Controller General of Patents, Designs and Trade Marks

पारस्परिकता तारीख (यदि कोई हो) जिसकी अनुमति देश के नाम पर की गई है। डिजाइन का सत्त्वाधिकार पंजीकरण की तारीख से दस वर्षों के लिए होगा जिसका विस्तार, अधिनियम एवं नियम के निबंधनों के अधीन, पाँच वर्षों की अतिरिक्त अवधि के लिए किया जा सकेगा। इस प्रमाण पत्र का उपयोग विधिक कार्यवाहियों अथवा विदेश में पंजीकरण प्राप्त करने के लिए नहीं हो सकता है।

*The reciprocity date (if any) which has been allowed and the name of the country. Copyright in the design will subsist for ten years from the date of Registration, and may under the terms of the Act and Rules, be extended for a further period of five years. This Certificate is not for use in legal proceedings or for obtaining registration abroad.



Intellectual
Property
Office

Certificate of Registration for a UK Design

Design number: 6279508

Grant date: 11 May 2023

Registration date: 30 April 2023

This is to certify that,

in pursuance of and subject to the provision of Registered Designs Act 1949, the design of which a representation or specimen is attached, had been registered as of the date of registration shown above in the name of

Dr. Muppaneni Srikanth, Dr. Chinmaya Mahapatra, Mr. Bikash Ranjan Jena, Dr.

Priyanka Debta , Chatlapelli Kishore , Deepak Shrivastava, Pragati Baghel,

Satyabrata Jena

in respect of the application of such design to:

EXTENSIVE DEVICE TO ANALYZE AND DESIGN TO FORMULATE HERBAL

DRUGS

International Design Classification:

Version: 14-2023

Class: 24 MEDICAL AND LABORATORY EQUIPMENT

Subclass: 01 APPARATUS AND EQUIPMENT FOR DOCTORS, HOSPITALS
AND LABORATORIES

Adam Williams

Comptroller-General of Patents, Designs and Trade Marks

Intellectual Property Office

The attention of the Proprietor(s) is drawn to the important notes overleaf.





ORIGINAL

मूल/No : 136833



भारत सरकार
GOVERNMENT OF INDIA
पेटेंट कार्यालय
THE PATENT OFFICE

डिजाइन के पंजीकरण का प्रमाणपत्र
CERTIFICATE OF REGISTRATION OF DESIGN

डिजाइन सं. / Design No. : 348483-001
तारीख / Date : 27/08/2021
पारस्परिकता तारीख / Reciprocity Date* :
देश / Country :

प्रमाणित किया जाता है कि संलग्न प्रति में वर्णित डिजाइन जो **CENTERTABLE** से संबंधित है, का पंजीकरण, श्रेणी **06-03** में 1.Centurion University Of Technology And Management 2. Tapan Kumar Padhy 3.Hariharan Nelli 4.Dinesh Tej Kovelakonda 5.Suman Kumar Sudhanshu के नाम में उपर्युक्त संख्या और तारीख में कर लिया गया है।

Certified that the design of which a copy is annexed hereto has been registered as of the number and date given above in class **06-03** in respect of the application of such design to **CENTERTABLE** in the name of 1.Centurion University Of Technology And Management 2. Tapan Kumar Padhy 3.Hariharan Nelli 4.Dinesh Tej Kovelakonda 5.Suman Kumar Sudhanshu.

डिजाइन अधिनियम, 2000 तथा डिजाइन नियम, 2001 के अध्याधीन प्रावधानों के अनुसरण में।

In pursuance of and subject to the provisions of the Designs Act, 2000 and the Designs Rules, 2001.

INTELLECTUAL
PROPERTY INDIA
PATENTS | DESIGNS | TRADE MARKS
GEOGRAPHICAL INDICATIONS

निर्गमन की तारीख/Date of Issue : 23/05/2023

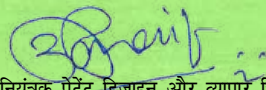
महानियंत्रक पेटेंट डिजाइन और व्यापार चिह्न
Controller General of Patents, Designs and Trade Marks

पारस्परिकता तारीख (यदि कोई हो) जिसकी अनुमति देश के नाम पर की गई है। डिजाइन का सत्त्वाधिकार पंजीकरण की तारीख से दस वर्षों के लिए होगा जिसका विस्तार, अधिनियम एवं नियम के निबंधनों के अधीन, पाँच वर्षों की अतिरिक्त अवधि के लिए किया जा सकेगा। इस प्रमाण पत्र का उपयोग विधिक कार्यवाहियों अथवा विदेश में पंजीकरण प्राप्त करने के लिए नहीं हो सकता है।

*The reciprocity date (if any) which has been allowed and the name of the country. Copyright in the design will subsist for ten years from the date of Registration, and may under the terms of the Act and Rules, be extended for a further period of five years. This Certificate is not for use in legal proceedings or for obtaining registration abroad.



ORIGINAL

मूल/No : 137966



भारत सरकार
GOVERNMENT OF INDIA
पेटेंट कार्यालय
THE PATENT OFFICE

डिजाइन के पंजीकरण का प्रमाणपत्र
CERTIFICATE OF REGISTRATION OF DESIGN

डिजाइन सं. / Design No. : 348486-001
तारीख / Date : 27/08/2021
पारस्परिकता तारीख / Reciprocity Date* :
देश / Country :

प्रमाणित किया जाता है कि संलग्न प्रति में वर्णित डिजाइन जो **LOFT BED** से संबंधित है, का पंजीकरण, श्रेणी **06-02** में 1.Centurion University Of Technology And Management 2. Tapan Kumar Padhy 3.Hariharan Nelli 4.Dinesh Tej Kovelakonda 5.Suman Kumar Sudhanshu के नाम में उपर्युक्त संख्या और तारीख में कर लिया गया है।

Certified that the design of which a copy is annexed hereto has been registered as of the number and date given above in class **06-02** in respect of the application of such design to **LOFT BED** in the name of 1.Centurion University Of Technology And Management 2. Tapan Kumar Padhy 3.Hariharan Nelli 4.Dinesh Tej Kovelakonda 5.Suman Kumar Sudhanshu.

डिजाइन अधिनियम, 2000 तथा डिजाइन नियम, 2001 के अध्याधीन प्रावधानों के अनुसरण में।

In pursuance of and subject to the provisions of the Designs Act, 2000 and the Designs Rules, 2001.

INTELLECTUAL
PROPERTY INDIA
PATENTS | DESIGNS | TRADE MARKS
GEOGRAPHICAL INDICATIONS

निर्गमन की तारीख/Date of Issue : 25/05/2023

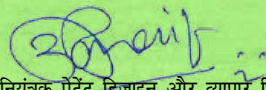
महानियंत्रक पेटेंट डिजाइन और व्यापार चिह्न
Controller General of Patents, Designs and Trade Marks

पारस्परिकता तारीख (यदि कोई हो) जिसकी अनुमति देश के नाम पर की गई है। डिजाइन का सत्त्वाधिकार पंजीकरण की तारीख से दस वर्षों के लिए होगा जिसका विस्तार, अधिनियम एवं नियम के निबंधनों के अधीन, पाँच वर्षों की अतिरिक्त अवधि के लिए किया जा सकेगा। इस प्रमाण पत्र का उपयोग विधिक कार्यवाहियों अथवा विदेश में पंजीकरण प्राप्त करने के लिए नहीं हो सकता है।

*The reciprocity date (if any) which has been allowed and the name of the country. Copyright in the design will subsist for ten years from the date of Registration, and may under the terms of the Act and Rules, be extended for a further period of five years. This Certificate is not for use in legal proceedings or for obtaining registration abroad.



ORIGINAL

मूल/No : 137213



भारत सरकार
GOVERNMENT OF INDIA
पेटेंट कार्यालय
THE PATENT OFFICE

डिजाइन के पंजीकरण का प्रमाणपत्र
CERTIFICATE OF REGISTRATION OF DESIGN

डिजाइन सं. / Design No. : 357338-001
तारीख / Date : 26/01/2022
पारस्परिकता तारीख / Reciprocity Date* :
देश / Country :

प्रमाणित किया जाता है कि संलग्न प्रति में वर्णित डिजाइन जो **E-GARBAGE DISPOSAL VAN** से संबंधित है, का पंजीकरण, श्रेणी **12-13** में 1.Centurion University Of Technology & Management (Cutm) 2. Avinash Kumar Singh 3.Mukundjee Pandey के नाम में उपर्युक्त संख्या और तारीख में कर लिया गया है।

Certified that the design of which a copy is annexed hereto has been registered as of the number and date given above in class **12-13** in respect of the application of such design to **E-GARBAGE DISPOSAL VAN** in the name of 1.Centurion University Of Technology & Management (Cutm) 2. Avinash Kumar Singh 3.Mukundjee Pandey.

डिजाइन अधिनियम, 2000 तथा डिजाइन नियम, 2001 के अध्याधीन प्रावधानों के अनुसरण में।

In pursuance of and subject to the provisions of the Designs Act, 2000 and the Designs Rules, 2001.

INTELLECTUAL
PROPERTY INDIA
PATENTS | DESIGNS | TRADE MARKS
GEOGRAPHICAL INDICATIONS

निर्गमन की तारीख/Date of Issue : 23/05/2023

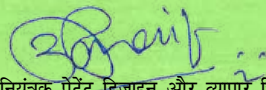
महानियंत्रक पेटेंट डिजाइन और व्यापार चिह्न
Controller General of Patents, Designs and Trade Marks

पारस्परिकता तारीख (यदि कोई हो) जिसकी अनुमति देश के नाम पर की गई है। डिजाइन का सत्त्वाधिकार पंजीकरण की तारीख से दस वर्षों के लिए होगा जिसका विस्तार, अधिनियम एवं नियम के निबंधनों के अधीन, पाँच वर्षों की अतिरिक्त अवधि के लिए किया जा सकेगा। इस प्रमाण पत्र का उपयोग विधिक कार्यवाहियों अथवा विदेश में पंजीकरण प्राप्त करने के लिए नहीं हो सकता है।

*The reciprocity date (if any) which has been allowed and the name of the country. Copyright in the design will subsist for ten years from the date of Registration, and may under the terms of the Act and Rules, be extended for a further period of five years. This Certificate is not for use in legal proceedings or for obtaining registration abroad.



ORIGINAL

मूल/No : 135884



भारत सरकार
GOVERNMENT OF INDIA
पेटेंट कार्यालय
THE PATENT OFFICE

डिजाइन के पंजीकरण का प्रमाणपत्र
CERTIFICATE OF REGISTRATION OF DESIGN

डिजाइन सं. / Design No. : 379893-001
तारीख / Date : 22/02/2023
पारस्परिकता तारीख / Reciprocity Date* :
देश / Country :

प्रमाणित किया जाता है कि संलग्न प्रति में वर्णित डिजाइन जो **RENEWABLE ENERGY POWERED POLES TO DETECT NOISE POLLUTION** से संबंधित है, का पंजीकरण, श्रेणी 10-05 में 1.Dr.Saine Sikta Dash 2. Dr.Sasmita Behera 3.Prof.Saswat Mishra 4.Dr.Siba Prasad Mishra 5.Prof. Deepak Kumar Sahu 6.Dr.Jyoti Prakash Giri 7.Dr.Prangya Parimita Pradhan 8.Prof.Priyanka Mishra 9.Prof.Nimay Chandra Giri के नाम में उपर्युक्त संख्या और तारीख में कर लिया गया है।

Certified that the design of which a copy is annexed hereto has been registered as of the number and date given above in class **10-05** in respect of the application of such design to **RENEWABLE ENERGY POWERED POLES TO DETECT NOISE POLLUTION** in the name of 1.Dr.Saine Sikta Dash 2. Dr.Sasmita Behera 3.Prof.Saswat Mishra 4.Dr.Siba Prasad Mishra 5.Prof. Deepak Kumar Sahu 6.Dr.Jyoti Prakash Giri 7.Dr.Prangya Parimita Pradhan 8.Prof.Priyanka Mishra 9.Prof.Nimay Chandra Giri.

डिजाइन अधिनियम, 2000 तथा डिजाइन नियम, 2001 के अध्यक्षीन प्रावधानों के अनुसरण में।

In pursuance of and subject to the provisions of the Designs Act, 2000 and the Designs Rules, 2001.

INTELLECTUAL
PROPERTY INDIA
PATENTS | DESIGNS | TRADE MARKS
GEOGRAPHICAL INDICATIONS

निर्गमन की तारीख/Date of Issue : 17/05/2023

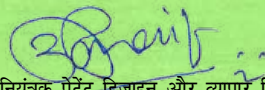
महानियंत्रक पेटेंट डिजाइन और व्यापार चिह्न
Controller General of Patents, Designs and Trade Marks

पारस्परिकता तारीख (यदि कोई हो) जिसकी अनुमति देश के नाम पर की गई है। डिजाइन का सत्त्वाधिकार पंजीकरण की तारीख से दस वर्षों के लिए होगा जिसका विस्तार, अधिनियम एवं नियम के निबंधनों के अधीन, पाँच वर्षों की अतिरिक्त अवधि के लिए किया जा सकेगा। इस प्रमाण पत्र का उपयोग विधिक कार्यवाहियों अथवा विदेश में पंजीकरण प्राप्त करने के लिए नहीं हो सकता है।

*The reciprocity date (if any) which has been allowed and the name of the country. Copyright in the design will subsist for ten years from the date of Registration, and may under the terms of the Act and Rules, be extended for a further period of five years. This Certificate is not for use in legal proceedings or for obtaining registration abroad.



ORIGINAL

मूल/No : 136484



भारत सरकार
GOVERNMENT OF INDIA
पेटेंट कार्यालय
THE PATENT OFFICE

डिजाइन के पंजीकरण का प्रमाणपत्र
CERTIFICATE OF REGISTRATION OF DESIGN

डिजाइन सं. / Design No. : 380508-001
तारीख / Date : 01/03/2023
पारस्परिकता तारीख / Reciprocity Date* :
देश / Country :

प्रमाणित किया जाता है कि संलग्न प्रति में वर्णित डिजाइन जो **SOLAR BIOMASS INTEGRATED CROP DRYER** से संबंधित है, का पंजीकरण, श्रेणी **15-03** में 1.Prof. Poulomi Chatterjee 2. Prof. Amit Kumar 3.Prof. Susovan Dutta 4.Dr. Susmita Das 5.Ar. Teesha Majumder 6.Dr. Sanjeeta Biswas 7.Dr. Devegowda S R 8.Prof. Prasheet Mishra 9.Dr.Nimay Chandra Giri के नाम में उपर्युक्त संख्या और तारीख में कर लिया गया है।

Certified that the design of which a copy is annexed hereto has been registered as of the number and date given above in class **15-03** in respect of the application of such design to **SOLAR BIOMASS INTEGRATED CROP DRYER** in the name of 1.Prof. Poulomi Chatterjee 2. Prof. Amit Kumar 3.Prof. Susovan Dutta 4.Dr. Susmita Das 5.Ar. Teesha Majumder 6.Dr. Sanjeeta Biswas 7.Dr. Devegowda S R 8.Prof. Prasheet Mishra 9.Dr.Nimay Chandra Giri.

डिजाइन अधिनियम, 2000 तथा डिजाइन नियम, 2001 के अध्याधीन प्रावधानों के अनुसरण में।

In pursuance of and subject to the provisions of the Designs Act, 2000 and the Designs Rules, 2001.

INTELLECTUAL
PROPERTY INDIA
PATENTS | DESIGNS | TRADE MARKS
GEOGRAPHICAL INDICATIONS

निर्गमन की तारीख/Date of Issue : 18/05/2023

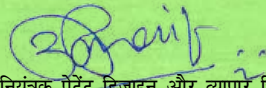
महानियंत्रक पेटेंट डिजाइन और व्यापार चिह्न
Controller General of Patents, Designs and Trade Marks

पारस्परिकता तारीख (यदि कोई हो) जिसकी अनुमति देश के नाम पर की गई है। डिजाइन का सत्त्वाधिकार पंजीकरण की तारीख से दस वर्षों के लिए होगा जिसका विस्तार, अधिनियम एवं नियम के निबंधनों के अधीन, पाँच वर्षों की अतिरिक्त अवधि के लिए किया जा सकेगा। इस प्रमाण पत्र का उपयोग विधिक कार्यवाहियों अथवा विदेश में पंजीकरण प्राप्त करने के लिए नहीं हो सकता है।

*The reciprocity date (if any) which has been allowed and the name of the country. Copyright in the design will subsist for ten years from the date of Registration, and may under the terms of the Act and Rules, be extended for a further period of five years. This Certificate is not for use in legal proceedings or for obtaining registration abroad.



ORIGINAL

मूल/No : 138096



भारत सरकार
GOVERNMENT OF INDIA
पेटेंट कार्यालय
THE PATENT OFFICE

डिजाइन के पंजीकरण का प्रमाणपत्र
CERTIFICATE OF REGISTRATION OF DESIGN

डिजाइन सं. / Design No. : 380801-001
तारीख / Date : 04/03/2023
पारस्परिकता तारीख / Reciprocity Date* :
देश / Country :

प्रमाणित किया जाता है कि संलग्न प्रति में वर्णित डिजाइन जो **FLOATING SOLAR PHOTOVOLTAIC CELL** से संबंधित है, का पंजीकरण, श्रेणी **13-04** में 1.Prof.Poulomi Chatterjee 2. Prof.Amit Kumar 3.Prof.Debasis Chatterjee 4.Prof.Susovan Dutta 5.Dr.Alivarani Mohapatra 6.Dr.Debani Prasad Mishra 7.Dr.Siba Prasad Mishra 8.Dr.Prangya Parimita Pradhan 9.Dr.Nimay Chandra Giri के नाम में उपर्युक्त संख्या और तारीख में कर लिया गया है।

Certified that the design of which a copy is annexed hereto has been registered as of the number and date given above in class **13-04** in respect of the application of such design to **FLOATING SOLAR PHOTOVOLTAIC CELL** in the name of 1.Prof.Poulomi Chatterjee 2. Prof.Amit Kumar 3.Prof.Debasis Chatterjee 4.Prof.Susovan Dutta 5.Dr.Alivarani Mohapatra 6.Dr.Debani Prasad Mishra 7.Dr.Siba Prasad Mishra 8.Dr.Prangya Parimita Pradhan 9.Dr.Nimay Chandra Giri.

डिजाइन अधिनियम, 2000 तथा डिजाइन नियम, 2001 के अध्याधीन प्रावधानों के अनुसरण में।

In pursuance of and subject to the provisions of the Designs Act, 2000 and the Designs Rules, 2001.

INTELLECTUAL
PROPERTY INDIA
PATENTS | DESIGNS | TRADE MARKS
GEOGRAPHICAL INDICATIONS

निर्गमन की तारीख/Date of Issue : 25/05/2023

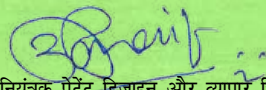
महानियंत्रक पेटेंट डिजाइन और व्यापार चिह्न
Controller General of Patents, Designs and Trade Marks

पारस्परिकता तारीख (यदि कोई हो) जिसकी अनुमति देश के नाम पर की गई है। डिजाइन का सत्त्वाधिकार पंजीकरण की तारीख से दस वर्षों के लिए होगा जिसका विस्तार, अधिनियम एवं नियम के निबंधनों के अधीन, पाँच वर्षों की अतिरिक्त अवधि के लिए किया जा सकेगा। इस प्रमाण पत्र का उपयोग विधिक कार्यवाहियों अथवा विदेश में पंजीकरण प्राप्त करने के लिए नहीं हो सकता है।

*The reciprocity date (if any) which has been allowed and the name of the country. Copyright in the design will subsist for ten years from the date of Registration, and may under the terms of the Act and Rules, be extended for a further period of five years. This Certificate is not for use in legal proceedings or for obtaining registration abroad.



ORIGINAL

मूल/No : 137345



भारत सरकार
GOVERNMENT OF INDIA
पेटेंट कार्यालय
THE PATENT OFFICE

डिजाइन के पंजीकरण का प्रमाणपत्र
CERTIFICATE OF REGISTRATION OF DESIGN

डिजाइन सं. / Design No. : 352888-001
तारीख / Date : 10/11/2021
पारस्परिकता तारीख / Reciprocity Date* :
देश / Country :

प्रमाणित किया जाता है कि संलग्न प्रति में वर्णित डिजाइन जो **A MEDICAL NEEDLE STERILIZATION BOX** से संबंधित है, का पंजीकरण, श्रेणी **24-02** में 1.Dr. Ranjan Kumar Mohapatra 2. Dr.Ashish Kumar Sarangi 3.Dr.Pranab Kishor Mohapatra 4.Dr.Alok Ranjan Sahu के नाम में उपर्युक्त संख्या और तारीख में कर लिया गया है।

Certified that the design of which a copy is annexed hereto has been registered as of the number and date given above in class **24-02** in respect of the application of such design to **A MEDICAL NEEDLE STERILIZATION BOX** in the name of 1.Dr. Ranjan Kumar Mohapatra 2. Dr.Ashish Kumar Sarangi 3.Dr.Pranab Kishor Mohapatra 4.Dr.Alok Ranjan Sahu.

डिजाइन अधिनियम, 2000 तथा डिजाइन नियम, 2001 के अध्याधीन प्रावधानों के अनुसरण में।

In pursuance of and subject to the provisions of the Designs Act, 2000 and the Designs Rules, 2001.

INTELLECTUAL
PROPERTY INDIA
PATENTS | DESIGNS | TRADE MARKS
GEOGRAPHICAL INDICATIONS

निर्गमन की तारीख/Date of Issue : 23/05/2023

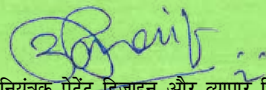

महानियंत्रक पेटेंट डिजाइन और व्यापार चिह्न
Controller General of Patents, Designs and Trade Marks

पारस्परिकता तारीख (यदि कोई हो) जिसकी अनुमति देश के नाम पर की गई है। डिजाइन का सत्त्वाधिकार पंजीकरण की तारीख से दस वर्षों के लिए होगा जिसका विस्तार, अधिनियम एवं नियम के निबंधनों के अधीन, पाँच वर्षों की अतिरिक्त अवधि के लिए किया जा सकेगा। इस प्रमाण पत्र का उपयोग विधिक कार्यवाहियों अथवा विदेश में पंजीकरण प्राप्त करने के लिए नहीं हो सकता है।

*The reciprocity date (if any) which has been allowed and the name of the country. Copyright in the design will subsist for ten years from the date of Registration, and may under the terms of the Act and Rules, be extended for a further period of five years. This Certificate is not for use in legal proceedings or for obtaining registration abroad.

ORIGINAL

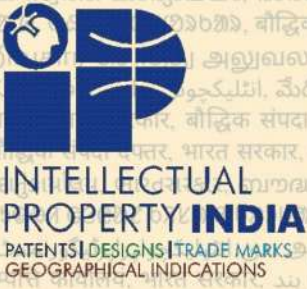
क्रम सं/ Serial No. : 139064



INTELLECTUAL PROPERTY INDIA PATENTS | DESIGNS | TRADE MARKS | GEOGRAPHICAL INDICATIONS

सत्यमेव जयते

पेटेंट कार्यालय, भारत सरकार

The Patent Office, Government Of India

डिजाइन के पंजीकरण का प्रमाण पत्र

Certificate of Registration of Design

डिजाइन सं. / Design No. : 348488-001

तारीख / Date : 27/08/2021

पारस्परिकता तारीख / Reciprocity Date* :

देश / Country :

प्रमाणित किया जाता है कि संलग्न प्रति में वर्णित डिजाइन जो SOFA SET से संबंधित है, का पंजीकरण, श्रेणी 06-01 में 1.Centurion University Of Technology And Management 2. Tapan Kumar Padhy 3.Hariharan Nelli 4.Dinesh Tej Kovelakonda 5.Suman Kumar Sudhanshu के नाम में उपर्युक्त संख्या और तारीख में कर लिया गया है।

Certified that the design of which a copy is annexed hereto has been registered as of the number and date given above in class 06-01 in respect of the application of such design to SOFA SET in the name of 1.Centurion University Of Technology And Management 2. Tapan Kumar Padhy 3.Hariharan Nelli 4.Dinesh Tej Kovelakonda 5.Suman Kumar Sudhanshu.

डिजाइन अधिनियम, 2000 तथा डिजाइन नियम, 2001 के अधधीन प्रावधानों के अनुसरण में। In pursuance of and subject to the provisions of the Designs Act, 2000 and the Designs Rules, 2001.

जारी करने की तिथि : 07/06/2023 Date of Issue



महानियंत्रक पेटेंट, डिजाइन और व्यापार चिह्न

Controller General of Patents, Designs and Trade Marks

*पारस्परिकता तारीख (यदि कोई हो) जिसकी अनुमति दी गई है तथा देश का नाम। डिजाइन का स्वत्वाधिकार पंजीकरण की तारीख से दस वर्षों के लिए होगा जिसका विस्तार, अधिनियम एवं नियम के निबंधनों के अधीन, पाँच वर्षों की अतिरिक्त अवधि के लिए किया जा सकेगा। इस प्रमाण पत्र का उपयोग विधिक कार्यवाहियों अथवा विदेश में पंजीकरण प्राप्त करने के लिए नहीं हो सकता है।

The reciprocity date (if any) which has been allowed and the name of the country. Copyright in the design will subsist for ten years from the date of Registration, and may under the terms of the Act and Rules, be extended for a further period of five years. This Certificate is not for use in legal proceedings or for obtaining registration abroad.



Intellectual
Property
Office

Certificate of Registration for a UK Design

Design number: 6285107

Grant date: 09 June 2023

Registration date: 24 May 2023

This is to certify that,

in pursuance of and subject to the provision of Registered Designs Act 1949, the design of which a representation or specimen is attached, had been registered as of the date of registration shown above in the name of

Dr. Ashok Misra, Dr. Banitamani Mallik, Ms. Nagalapalli Jeebaratnam, Ms.

Gedala Sridevi, Dr. Sujit Mishra, Mr. Debarghya De, Ms. Priya Khanda

in respect of the application of such design to:

Water quality prediction device

International Design Classification:

Version: 14-2023

Class: 10 CLOCKS AND WATCHES AND OTHER MEASURING
INSTRUMENTS, CHECKING AND SIGNALLING INSTRUMENTS

Subclass: 05 INSTRUMENTS, APPARATUS AND DEVICES FOR CHECKING,
SECURITY OR TESTING

Adam Williams

Comptroller-General of Patents, Designs and Trade Marks

Intellectual Property Office

The attention of the Proprietor(s) is drawn to the important notes overleaf.



Representation of Designs









Intellectual Property Office is an operating name of the Patent Office

www.gov.uk/ipo



Design details

Design application number

6285107

Filing date (provisional)

24 May 2023

Defer registration

No

Design

Water quality prediction device

Additional description

Water quality prediction device

Illustration disclaimer

No claim is made to the colour shown in the drawings

Illustrations

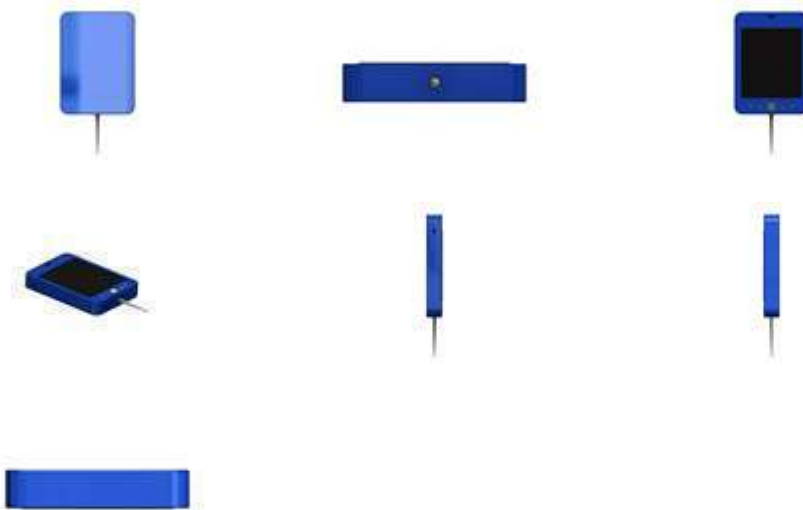

Repeated surface pattern

No

Priority claims

None

Owner details

Dr. Ashok Misra

Professor, Department of Mathematics, Centurion University of Technology and Management, Paralakhemundi, Aluri Nagar, R.Sithapur, Upalada, Gajapati, Odisha, 761211, India

Dr. Banitamani Mallik

Professor, Department of Mathematics, Centurion University of Technology and Management, Paralakhemundi, Aluri Nagar, R.Sithapur, Upalada, Gajapati, Odisha, 761211, India

Ms. N Jeebaratnam

Assistant Professor, Department of ECE, Centurion University of Technology and Management, Paralakhemundi, Aluri Nagar, R.Sithapur, Upalada, Gajapati, Odisha, 761211, India

Ms. G Sreedevi

Assistant Professor, Department of ME, Centurion University of Technology and Management, Paralakhemundi, Aluri Nagar, R.Sithapur, Upalada, Gajapati, Odisha, 761211, India

Dr. Sujit Mishra

Assistant Professor, Department of ME, Centurion University of Technology and Management, Paralakhemundi, Aluri Nagar, R.Sithapur, Upalada, Gajapati, Odisha, 761211, India

Mr. Debarghya De

Student, Department of Agriculture Engineering, Centurion University of Technology and Management, Paralakhemundi, Aluri Nagar, R.Sithapur, Upalada, Gajapati, Odisha, 761211, India

Ms. Priya Khanda

Student, Department of Agriculture Engineering, Centurion University of Technology and Management, Paralakhemundi, Aluri Nagar, R.Sithapur, Upalada, Gajapati, Odisha, 761211, India

Contact details



Reference: LXG 3994

Please note this is an uncertified copy of your registration document which you can use for research or personal use.

Design Application Details

Application Number:	381334-001
Cbr Number:	203171
Cbr Date:	12/03/2023 13:51:11
Applicant Name:	1. Dr. Dharmendra Ahuja 2. Hemlata Rathore 3. Ankit Kumar 4. Shmriti 5. Dr. Nihar Ranjan Kar 6. Ms. Linda Xavier 7. Mr. Abhijit Gupta

Design Application Status

Application Status: Design Accepted and Published, Journal No is 22/2023 and Journal Date is 02/06/2023

[Back](#)

Design Number	381334-001	
Class	10-05	
1. Dr. Dharmendra Ahuja Dean, Faculty of Pharmaceutical Science, Jayoti Vidyapeeth Women's University, Jaipur, Rajasthan, India 303122. 2. Hemlata Rathore Assistant Professor, Department of Pharmacognosy, School of Pharmacy Chouksey Engineering College Bilaspur, Chhattisgarh-495004, India. 3. Ankit Kumar Assistant Professor, Department of Paramedical Sciences, Subharti Medical College, Swami Vivekanand Subharti University, Meerut, Uttar Pradesh-250005, India. 4. Shmriti Assistant Professor, Department of Paramedical Sciences, Subharti Medical College, Swami Vivekanand Subharti University, Meerut, Uttar Pradesh-250005, India. , et al.		
Date of Registration	12/03/2023	
Title	TRANSDERMAL ALCOHOL MONITORING DEVICE	
Priority NA		

ORIGINAL

क्रम सं/ Serial No. : 138629



INTELLECTUAL PROPERTY INDIA PATENTS | DESIGNS | TRADE MARKS | GEOGRAPHICAL INDICATIONS



सत्यमेव जयते

पेटेंट कार्यालय, भारत सरकार

The Patent Office, Government Of India

डिजाइन के पंजीकरण का प्रमाण पत्र

Certificate of Registration of Design

डिजाइन सं. / Design No. : 381334-001

तारीख / Date : 12/03/2023

पारस्परिकता तारीख / Reciprocity Date* :

देश / Country :

प्रमाणित किया जाता है कि संलग्न प्रति में वर्णित डिजाइन जो TRANSDERMAL ALCOHOL MONITORING DEVICE से संबंधित है, का पंजीकरण, श्रेणी 10-05 में 1.Dr. Dharmendra Ahuja 2. Hemlata Rathore 3.Ankit Kumar 4.Shmriti 5.Dr. Nihar Ranjan Kar 6.Ms. Linda Xavier 7.Mr. Abhijit Gupta के नाम में उपर्युक्त संख्या और तारीख में कर लिया गया है।

Certified that the design of which a copy is annexed hereto has been registered as of the number and date given above in class 10-05 in respect of the application of such design to TRANSDERMAL ALCOHOL MONITORING DEVICE in the name of 1.Dr. Dharmendra Ahuja 2. Hemlata Rathore 3.Ankit Kumar 4.Shmriti 5.Dr. Nihar Ranjan Kar 6.Ms. Linda Xavier 7.Mr. Abhijit Gupta.

डिजाइन अधिनियम, 2000 तथा डिजाइन नियम, 2001 के अधधीन प्रावधानों के अनुसरण में।

In pursuance of and subject to the provisions of the Designs Act, 2000 and the Designs Rules, 2001.

जारी करने की तिथि : 01/06/2023 Date of Issue



महानियंत्रक पेटेंट, डिजाइन और व्यापार चिह्न

Controller General of Patents, Designs and Trade Marks

*पारस्परिकता तारीख (यदि कोई हो) जिसकी अनुमति दी गई है तथा देश का नाम। डिजाइन का स्वत्वाधिकार पंजीकरण की तारीख से दस वर्षों के लिए होगा जिसका विस्तार, अधिनियम एवं नियम के निबंधनों के अधीन, पाँच वर्षों की अतिरिक्त अवधि के लिए किया जा सकेगा। इस प्रमाण पत्र का उपयोग विधिक कार्यवाहियों अथवा विदेश में पंजीकरण प्राप्त करने के लिए नहीं हो सकता है।

The reciprocity date (if any) which has been allowed and the name of the country. Copyright in the design will subsist for ten years from the date of Registration, and may under the terms of the Act and Rules, be extended for a further period of five years. This Certificate is not for use in legal proceedings or for obtaining registration abroad.



Intellectual
Property
Office

Certificate of Registration for a UK Design

Design number: 6264907

Grant date: 07 March 2023

Registration date: 28 February 2023

This is to certify that,

in pursuance of and subject to the provision of Registered Designs Act 1949, the design of which a representation or specimen is attached, had been registered as of the date of registration shown above in the name of

Mr. Brijesh Kumar Saroj, Mr. Mohammad Muztaba, Ms. Sarita Verma, Dr. R.

Rajagopalan, Dr. Farhad F Mehta, Dr. Bhuwanendra Singh , Mrs. Mughisa

Nagori, Dr. Akhilesh Patel, Mr. Mohammad Haneef, Dr. Nihar Ranjan Kar

in respect of the application of such design to:

GLASS APPARATUS FOR SEPARATING PARTICLES FROM

PHARMACEUTICAL NANOSUSPENSION

International Design Classification:

Version: 14-2023

Class: 24 MEDICAL AND LABORATORY EQUIPMENT

Subclass: 02 MEDICAL INSTRUMENTS, INSTRUMENTS AND TOOLS FOR LABORATORY USE

Adam Williams

Comptroller-General of Patents, Designs and Trade Marks
Intellectual Property Office

The attention of the Proprietor(s) is drawn to the important notes overleaf.



Representation of Designs

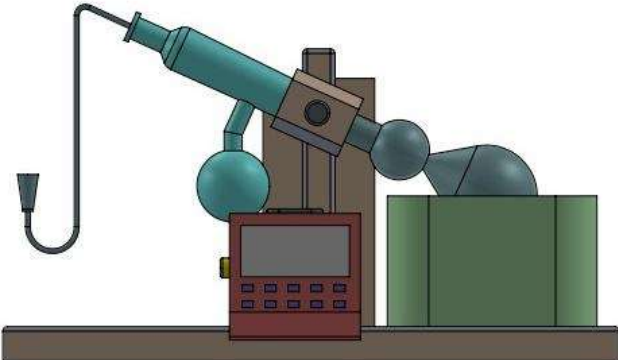
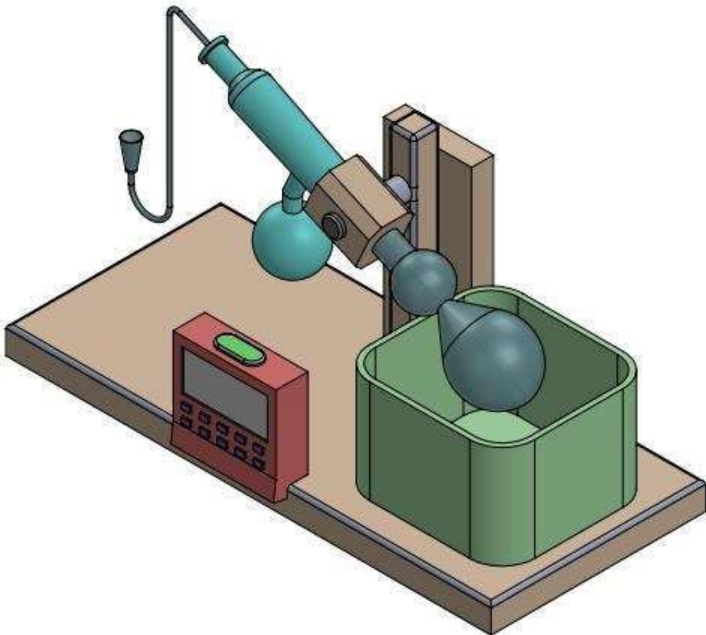

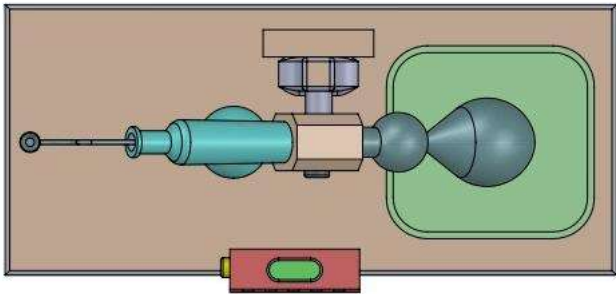
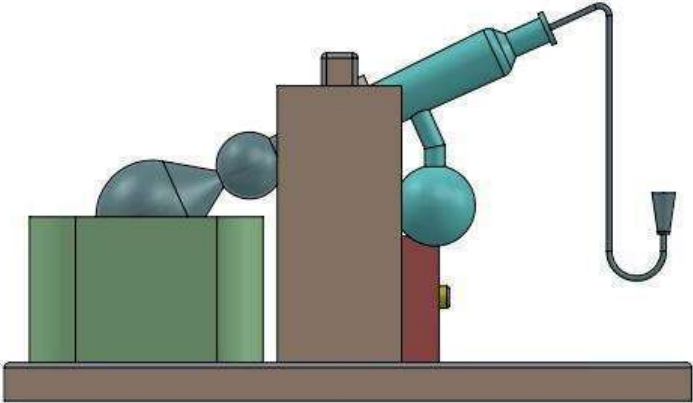

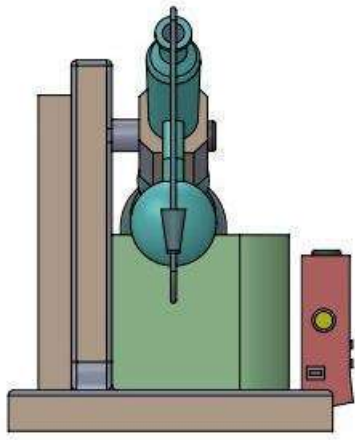
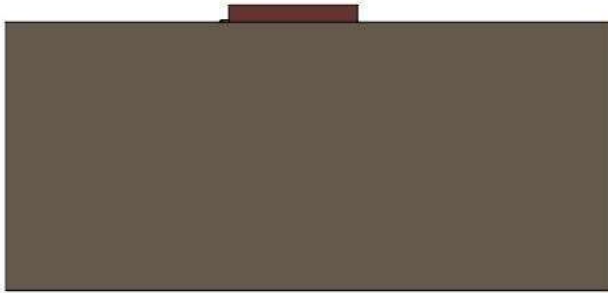

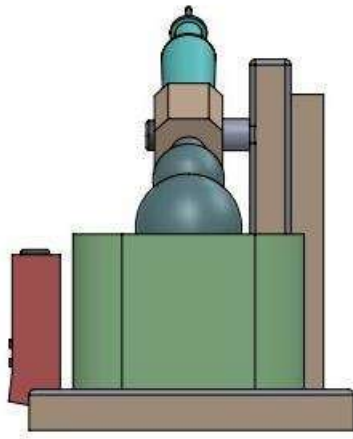

Intellectual Property Office is an operating name of the Patent Office

www.gov.uk/ipo



ORIGINAL
क्रम सं/ Serial No. : 140189



पेटेंट कार्यालय, भारत सरकार

The Patent Office, Government Of India

डिजाइन के पंजीकरण का प्रमाण पत्र

Certificate of Registration of Design

डिजाइन सं. / Design No. 382767-001

तारीख / Date 03/04/2023

पारस्परिकता तारीख / Reciprocity Date

देश / Country

प्रमाणित किया जाता है कि संलग्न प्रति में वर्णित डिजाइन जो **WASTEWATER TREATMENT DEVICE** से संबंधित है, का पंजीकरण, श्रेणी 23-01 में 1.Dr. Prafulla Kumar Panda 2. Dr. Rajib Kumar Majhi 3.Krushna Chandra Sethi 4.Mr. B. Bikram Narayan 5.Subhadarshani Satapathy 6.Dillip Kumar Baral के नाम में उपर्युक्त संख्या और तारीख में कर लिया गया है।

Certified that the design of which a copy is annexed hereto has been registered as of the number and date given above in class 23-01 in respect of the application of such design to **WASTEWATER TREATMENT DEVICE** in the name of 1.Dr. Prafulla Kumar Panda 2. Dr. Rajib Kumar Majhi 3.Krushna Chandra Sethi 4.Mr. B. Bikram Narayan 5.Subhadarshani Satapathy 6.Dillip Kumar Baral.

डिजाइन अधिनियम, 2000 तथा डिजाइन नियम, 2001 के अधधीन प्रावधानों के अनुसरण में।

In pursuance of and subject to the provisions of the Designs Act, 2000 and the Designs Rules, 2001.

जारी करने की तिथि : 06/07/2023
Date of Issue



(Signature)

महानियंत्रक पेटेंट, डिजाइन और व्यापार चिह्न
Controller General of Patents, Designs and Trade Marks

*पारस्परिकता तारीख (यदि कोई हो) जिसकी अनुमति दी गई है तथा देश का नाम। डिजाइन का स्वत्वाधिकार पंजीकरण की तारीख से दस वर्षों के लिए होगा जिसका विस्तार, अधिनियम एवं नियम के निबंधनों के अधीन, पांच वर्षों की अतिरिक्त अवधि के लिए किया जा सकेगा। इस प्रमाण पत्र का उपयोग विधिक कार्यवाहियों अथवा विदेश में पंजीकरण प्राप्त करने के लिए नहीं हो सकता है।
The reciprocity date (if any) which has been allowed and the name of the country. Copyright in the design will subsist for ten years from the date of Registration, and may under the terms of the Act and Rules, be extended for a further period of five years. This Certificate is not for use in legal proceedings or for obtaining registration abroad.



Intellectual
Property
Office

Certificate of Registration for a UK Design

Design number: 6297798

Grant date: 31 July 2023

Registration date: 20 July 2023

This is to certify that,

in pursuance of and subject to the provision of Registered Designs Act 1949, the design of which a representation or specimen is attached, had been registered as of the date of registration shown above in the name of

Dr. Shanmugarathinam Alagarsamy, Dr. Mohammad Ali, Dr. Nihar Ranjan Kar,

Mr. Mehul Batukbhai Vyas, Mr. Mineshkumar Ashvinkumar Patel, Dr. Ujwala

Sandip Dube, Dr. Rahil Bhura, Dr. Rinchi Bora, Dr. Sorabh Kumar Agrawal

in respect of the application of such design to:

Smart Dissolution Apparatus for Tablets & Capsules

International Design Classification:

Version: 14-2023

Class: 24 MEDICAL AND LABORATORY EQUIPMENT

Subclass: 01 APPARATUS AND EQUIPMENT FOR DOCTORS, HOSPITALS
AND LABORATORIES

Adam Williams

Comptroller-General of Patents, Designs and Trade Marks

Intellectual Property Office

The attention of the Proprietor(s) is drawn to the important notes overleaf.



Representation of Designs

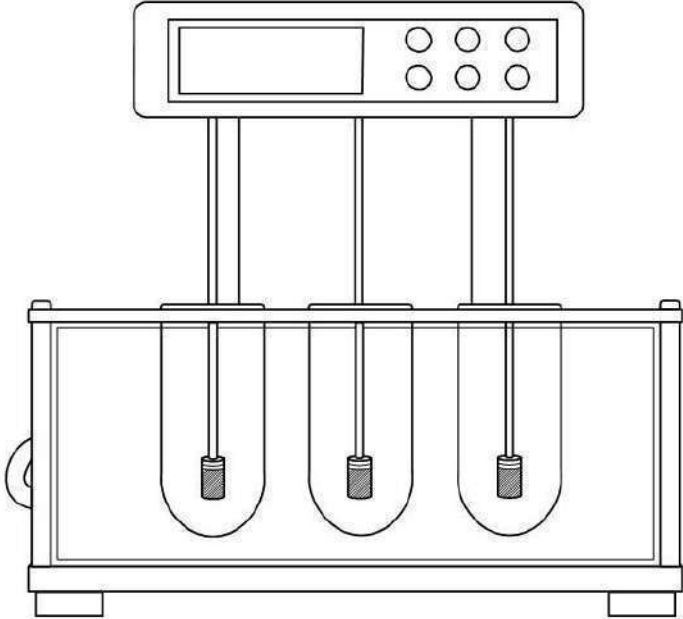
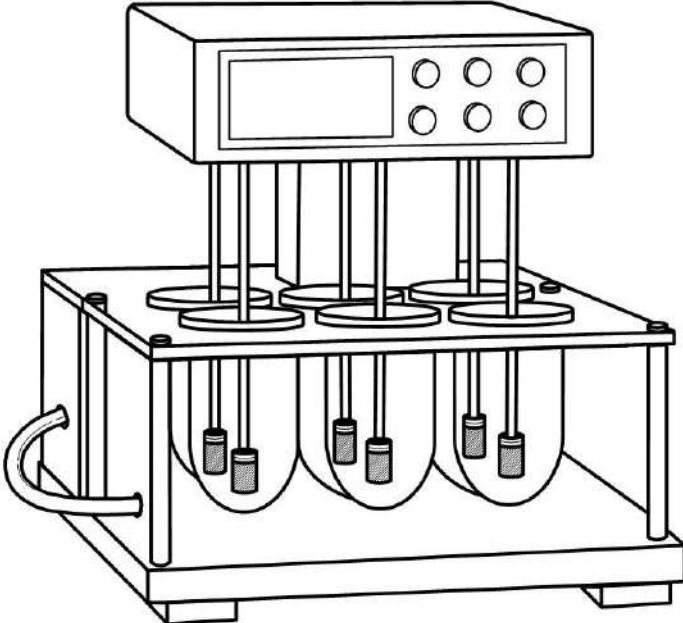

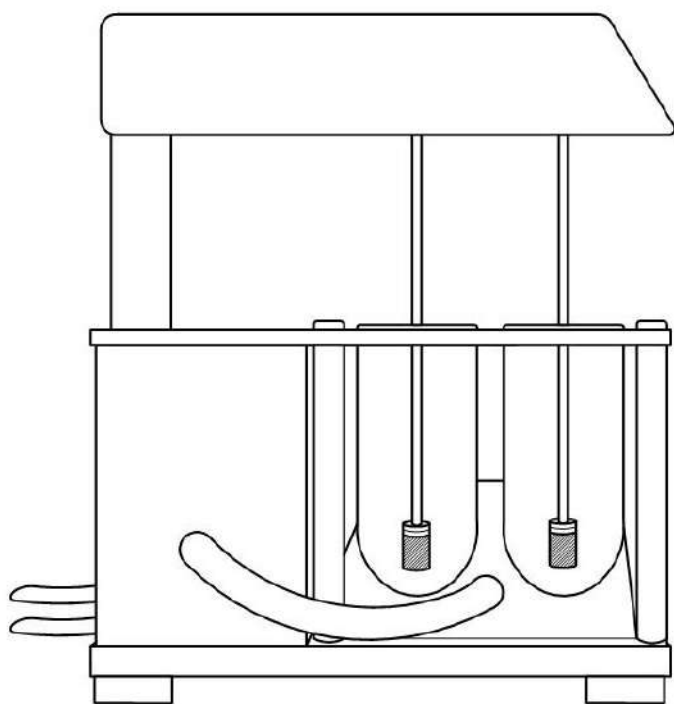
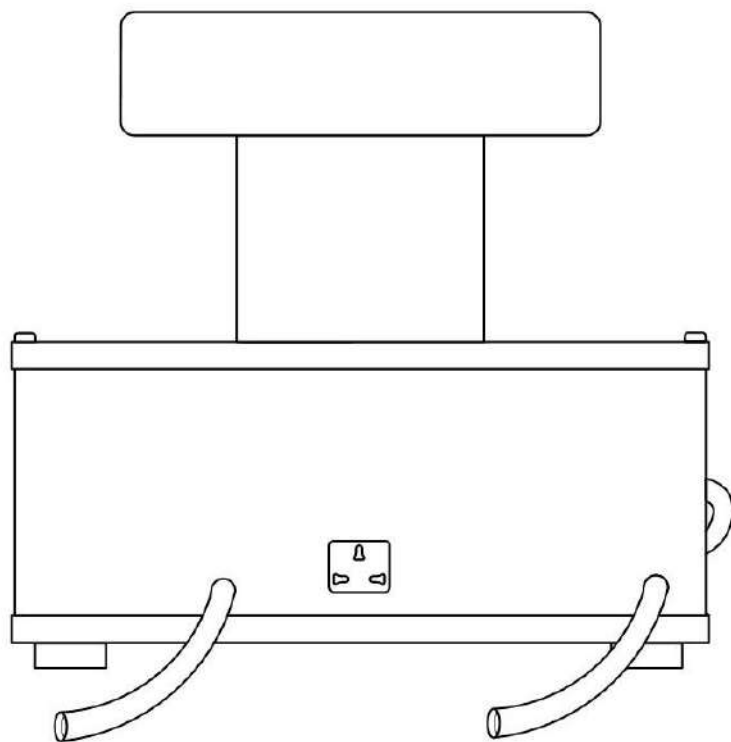

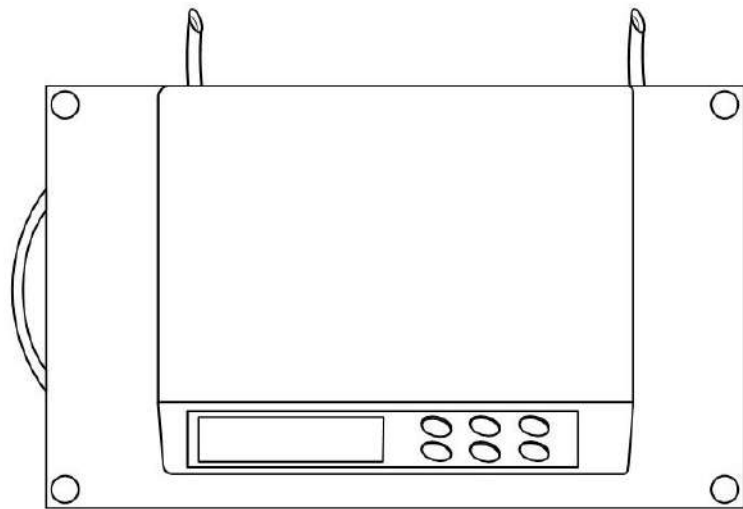
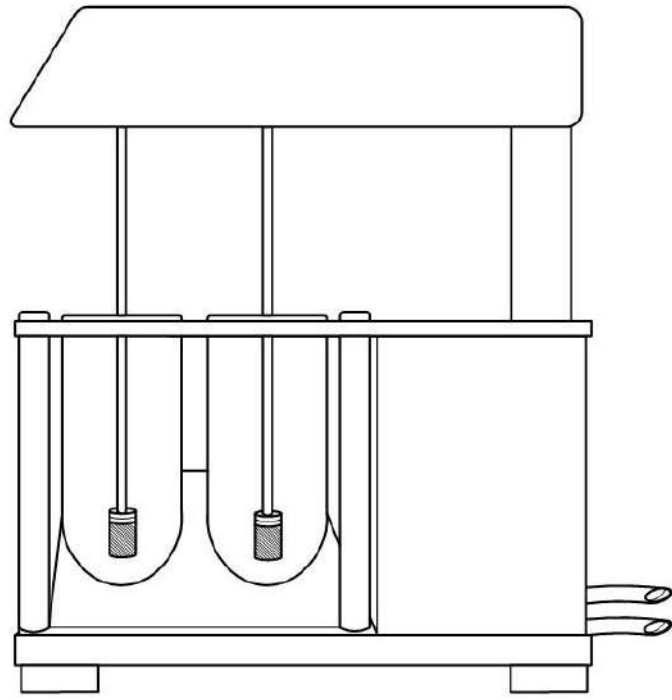

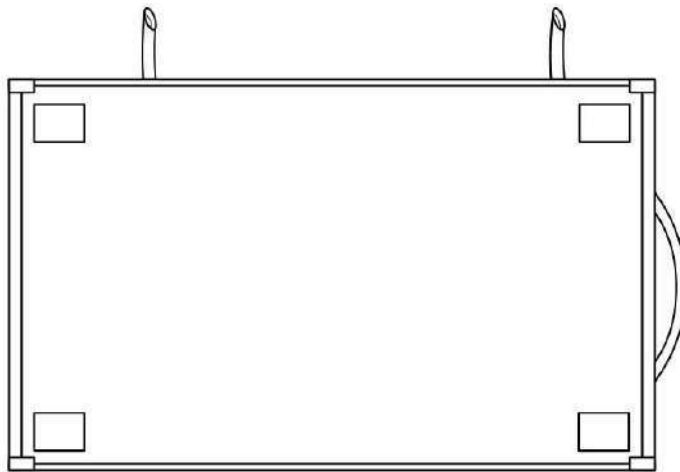

Intellectual Property Office is an operating name of the Patent Office

www.gov.uk/ipo

पेटेंट कार्यालय
शासकीय जर्नल

**OFFICIAL JOURNAL
OF
THE PATENT OFFICE**

निर्गमन सं. 27/2023
ISSUE NO. 27/2023

शुक्रवार
FRIDAY

दिनांक: 07/07/2023
DATE: 07/07/2023

पेटेंट कार्यालय का एक प्रकाशन
PUBLICATION OF THE PATENT OFFICE

INTRODUCTION

In view of the recent amendment made in the Designs (Amendment) Rules, 2008 with effect from 17/06/2008, Publication of the matter relating to Designs is being published in the Official Journal of The Patent Office. This Journal is being published on weekly basis on every Friday covering the various proceedings on Designs as required according to the provisions of under Rule 22, 25, 27 and 39 of the Design (Amendment) Rules, 2008. All the enquiries on this Official Journal and other information as required by the public should be addressed to the Controller General of Patents, Designs & Trade Marks. Suggestions and comments are requested from all quarters so that the content can be enriched.

Design Application Details

Application Number: 382987-001
Cbr Number: 204220
Cbr Date: 04/04/2023 17:21:59
Applicant Name:
1. Mr. Arun Kumar
2. Mr. Afaq Raza Mehboob Ansari
3. Mr. Mohit Chadha
4. Dr. Mohammed Altaf Ahmed
5. Dr. Nihar Ranjan Kar
6. Dr. Shashank Soni
7. Mrs. Ketaki Suhas Shinde
8. Dr. Mohd Tanveer Khan
9. Dr. Kritika Suresh Garg
10. Mrs. Shruti Srivastava

Design Application Status

Application Status: Design Accepted and Published, Journal No is 27/2023 and Journal Date is 07/07/2023

[Back](#)

Design Number	382987-001
Class	15-99
Date of Registration	04/04/2023
Title	Fluid bed granulator and bed dryer machine for pharmaceutical purpose
Priority NA	
1. Mr. Arun Kumar Assistant Professor, Arya College of Pharmacy, Nawabganj, Bareilly, Uttar Pradesh - 262001 2. Mr. Afaq Raza Mehboob Ansari Assistant Professor, D.S.T.S. Mandal's College of Pharmacy, Shivdare Campus, Vijapur Road, Solapur, Maharashtra - 413004 3. Mr. Mohit Chadha Assistant Professor, Baba Farid College of Pharmacy, Mullanpur, Ludhiana, Punjab - 142023 4. Dr. Mohammed Altaf Ahmed Principal, Ayesha College of Pharmacy, Hagarga Cross ring Road, Kalaburagi, Karnataka - 585104 , et al.	

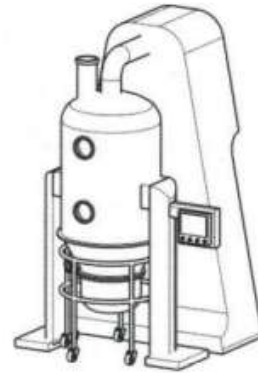



ORIGINAL
क्रम सं/ Serial No. : 140234



पेटेंट कार्यालय, भारत सरकार

The Patent Office, Government Of India

डिजाइन के पंजीकरण का प्रमाण पत्र | Certificate of Registration of Design

डिजाइन सं. / Design No. : 382987-001
 तारीख / Date : 04/04/2023
 पारस्परिकता तारीख / Reciprocity Date* :
 देश / Country :

प्रमाणित किया जाता है कि संलग्न प्रति में वर्णित डिजाइन जो **FLUID BED GRANULATOR AND BED DRYER MACHINE FOR PHARMACEUTICAL PURPOSE** से संबंधित है, का पंजीकरण, श्रेणी 15-99 में 1.Mr. Arun Kumar 2. Mr. Afaqe Raza Mehboob Ansari 3.Mr. Mohit Chadha 4.Dr. Mohammed Altaf Ahmed 5.Dr. Nihar Ranjan Kar 6.Dr. Shashank Soni 7.Mrs. Ketaki Suhas Shinde 8.Dr. Mohd Tanveer Khan 9.Dr. Kritika Suresh Garg 10.Mrs. Shruti Srivastava के नाम में उपर्युक्त संख्या और तारीख में कर लिया गया है।

Certified that the design of which a copy is annexed hereto has been registered as of the number and date given above in class 15-99 in respect of the application of such design to **FLUID BED GRANULATOR AND BED DRYER MACHINE FOR PHARMACEUTICAL PURPOSE** in the name of 1.Mr. Arun Kumar 2. Mr. Afaqe Raza Mehboob Ansari 3.Mr. Mohit Chadha 4.Dr. Mohammed Altaf Ahmed 5.Dr. Nihar Ranjan Kar 6.Dr. Shashank Soni 7.Mrs. Ketaki Suhas Shinde 8.Dr. Mohd Tanveer Khan 9.Dr. Kritika Suresh Garg 10.Mrs. Shruti Srivastava.

डिजाइन अधिनियम, 2000 तथा डिजाइन नियम, 2001 के अध्याधिन प्रावधानों के अनुसरण में।

In pursuance of and subject to the provisions of the Designs Act, 2000 and the Designs Rules, 2001.

जारी करने की तिथि : 06/07/2023
Date of Issue



महानियंत्रक पेटेंट, डिजाइन और व्यापार चिह्न
Controller General of Patents, Designs and Trade Marks

*पारस्परिकता तारीख (यदि कोई हो) जिसकी अनुमति दी गई है तथा देश का नाम। डिजाइन का स्वत्वाधिकार पंजीकरण की तारीख से दस वर्षों के लिए होगा जिसका विस्तार, अधिनियम एवं नियम के निबंधनों के अधीन, पाँच वर्षों की अतिरिक्त अवधि के लिए किया जा सकेगा। इस प्रमाण पत्र का उपयोग विधिक कार्यवाहियों अथवा विदेश में पंजीकरण प्राप्त करने के लिए नहीं हो सकता है।
The reciprocity date (if any) which has been allowed and the name of the country. Copyright in the design will subsist for ten years from the date of Registration, and may under the terms of the Act and Rules, be extended for a further period of five years. This Certificate is not for use in legal proceedings or for obtaining registration abroad.

पेटेंट कार्यालय
शासकीय जर्नल

**OFFICIAL JOURNAL
OF
THE PATENT OFFICE**

निर्गमन सं. 28/2023
ISSUE NO. 28/2023

शुक्रवार
FRIDAY

दिनांक: 14/07/2023
DATE: 14/07/2023

पेटेंट कार्यालय का एक प्रकाशन
PUBLICATION OF THE PATENT OFFICE

INTRODUCTION

In view of the recent amendment made in the Designs (Amendment) Rules, 2008 with effect from 17/06/2008, Publication of the matter relating to Designs is being published in the Official Journal of The Patent Office. This Journal is being published on weekly basis on every Friday covering the various proceedings on Designs as required according to the provisions of under Rule 22, 25, 27 and 39 of the Design (Amendment) Rules, 2008. All the enquiries on this Official Journal and other information as required by the public should be addressed to the Controller General of Patents, Designs & Trade Marks. Suggestions and comments are requested from all quarters so that the content can be enriched.

Design Application Details

Application Number: 383360-001
Cbr Number: 204412
Cbr Date: 08/04/2023 13:54:44
Applicant Name:
1. Dr. V Lokeswara Babu
2. Dr. Nihar Ranjan Kar
3. Professor Shital Vijay Sirsat
4. Dr. B. Srinivas
5. Dr. Abhishek Bhattacharjee
6. Dr. Anoop Kumar N
7. Aakrshan Kumar
8. Dr. Sandhya S
9. P.Prapulla
10. Mr. Rajat
11. Satyabrata Jena

Design Application Status

Application Status: Design Accepted and Published, Journal No is 28/2023 and Journal Date is 14/07/2023

[Back](#)

Design Number	383360-001
Class	15-99
Date of Registration	08/04/2023
Title	AUTOMATED TABLET PACKAGING MACHINE
Priority NA	
1. Dr. V Lokeswara Babu HOD & Associate Professor, Department of Pharmaceutics, Bhaskar Pharmacy College, Bhaskar Nagar, Rangareddy District, Hyderabad, Telangana, India -500075. 2. Dr. Nihar Ranjan Kar Assistant Professor, Centurion University of Technology and Management, Gopalpur, Balasore, Odisha, India -756044. 3. Professor Shital Vijay Sirsat Associate Professor, Department of Pharmaceutics, Shri Sant Gajanan Maharaj College of Pharmacy Buldhana, Maharashtra, India, Near Palnagar, Sagwan Road, At post Buldhana, Tal and District -Buldhana, India-443001. 4. Dr. B. Srinivas Assistant Professor, Department of Chemistry, Rajiv Gandhi University of Knowledge Technologies (RGUKT) Basar, Nirmal, Telangana, India - 504107., et al.	

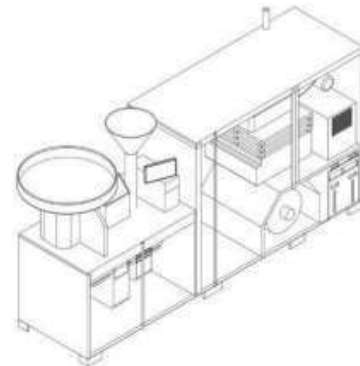



ORIGINAL
क्रम सं/ Serial No. : 140712



पेटेंट कार्यालय, भारत सरकार | The Patent Office, Government Of India

डिजाइन के पंजीकरण का प्रमाण पत्र | Certificate of Registration of Design

डिजाइन सं. / Design No. : 383360-001

तारीख / Date : 08/04/2023

पारस्परिकता तारीख / Reciprocity Date* :

देश / Country :

प्रमाणित किया जाता है कि संलग्न प्रति में वर्णित डिजाइन जो **AUTOMATED TABLET PACKAGING MACHINE** से संबंधित है, का पंजीकरण, श्रेणी 15-99 में 1.Dr. V Lokeswara Babu 2. Dr. Nihar Ranjan Kar 3.Professor Shital Vijay Sirsat 4.Dr. B. Srinivas 5.Dr. Abhishek Bhattacharjee 6.Dr. Anoop Kumar N 7.Aakrshan Kumar 8.Dr. Sandhya S 9.P.Prapulla 10.Mr. Rajat 11.Satyabrata Jena के नाम में उपर्युक्त संख्या और तारीख में कर लिया गया है।

Certified that the design of which a copy is annexed hereto has been registered as of the number and date given above in class 15-99 in respect of the application of such design to **AUTOMATED TABLET PACKAGING MACHINE** in the name of 1.Dr. V Lokeswara Babu 2. Dr. Nihar Ranjan Kar 3.Professor Shital Vijay Sirsat 4.Dr. B. Srinivas 5.Dr. Abhishek Bhattacharjee 6.Dr. Anoop Kumar N 7.Aakrshan Kumar 8.Dr. Sandhya S 9.P.Prapulla 10.Mr. Rajat 11.Satyabrata Jena.

डिजाइन अधिनियम, 2000 तथा डिजाइन नियम, 2001 के अधधीन प्रावधानों के अनुसरण में।

In pursuance of and subject to the provisions of the Designs Act, 2000 and the Designs Rules, 2001.

जारी करने की तिथि : 13/07/2023
Date of Issue



महानियंत्रक पेटेंट, डिजाइन और व्यापार चिह्न
Controller General of Patents, Designs and Trade Marks

*पारस्परिकता तारीख (यदि कोई हो) जिसकी अनुमति दी गई है तथा देश का नाम। डिजाइन का स्वत्वाधिकार पंजीकरण की तारीख से दस वर्षों के लिए होगा जिसका विस्तार, अधिनियम एवं नियम के निबंधनों के अधीन, पाँच वर्षों की अतिरिक्त अवधि के लिए किया जा सकेगा। इस प्रमाण पत्र का उपयोग विधिक कार्यवाहियों अथवा विदेश में पंजीकरण प्राप्त करने के लिए नहीं हो सकता है।
The reciprocity date (if any) which has been allowed and the name of the country. Copyright in the design will subsist for ten years from the date of Registration, and may under the terms of the Act and Rules, be extended for a further period of five years. This Certificate is not for use in legal proceedings or for obtaining registration abroad.



Intellectual
Property
Office

Certificate of Registration for a UK Design

Design number: 6288630

Grant date: 17 June 2023

Registration date: 08 June 2023

This is to certify that,

in pursuance of and subject to the provision of Registered Designs Act 1949, the design of which a representation or specimen is attached, had been registered as of the date of registration shown above in the name of

Dr. Chinmaya Mahapatra, Dr. Subas Chandra Dinda, Dr. Hara Prasad Mishra,

Ms. Smruti Sikta Mishra, Mr. Abhra Das, Dr. Lubhan Singh, Mr.Om Prakash

Panda, Mr.Sanatan Nayak

in respect of the application of such design to:

IOT Device for Breast Cancer Detection

International Design Classification:

Version: 14-2023

Class: 24 MEDICAL AND LABORATORY EQUIPMENT

Subclass: 01 APPARATUS AND EQUIPMENT FOR DOCTORS, HOSPITALS
AND LABORATORIES

Adam Williams

Comptroller-General of Patents, Designs and Trade Marks

Intellectual Property Office

The attention of the Proprietor(s) is drawn to the important notes overleaf.



Representation of Designs

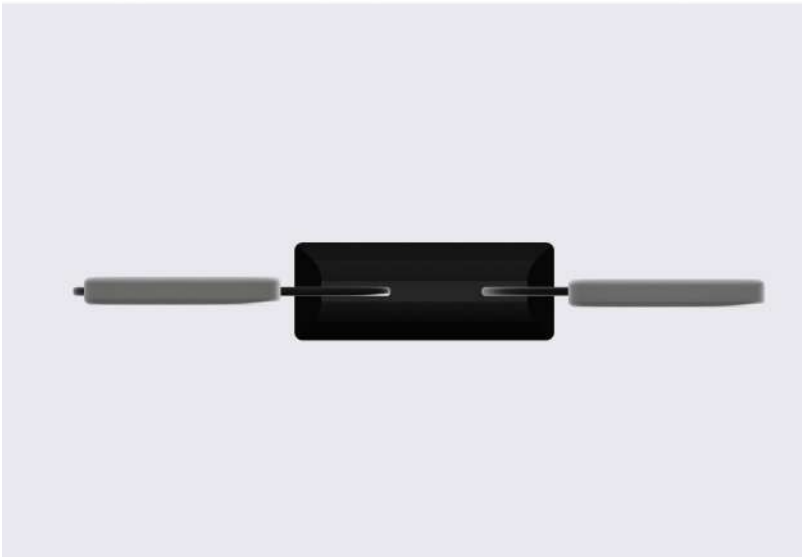

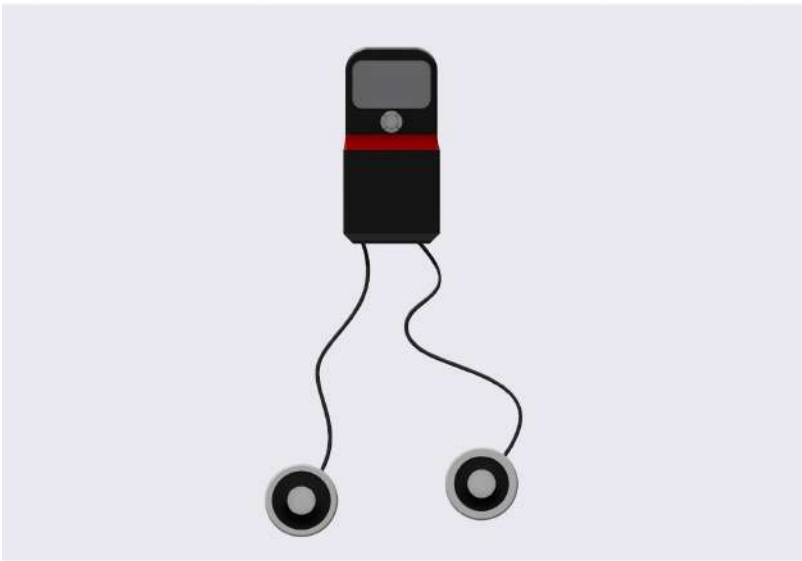

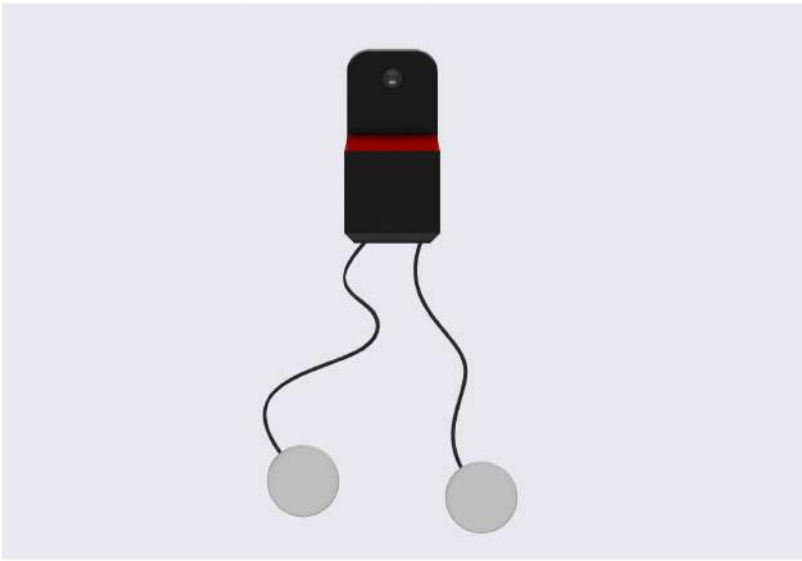
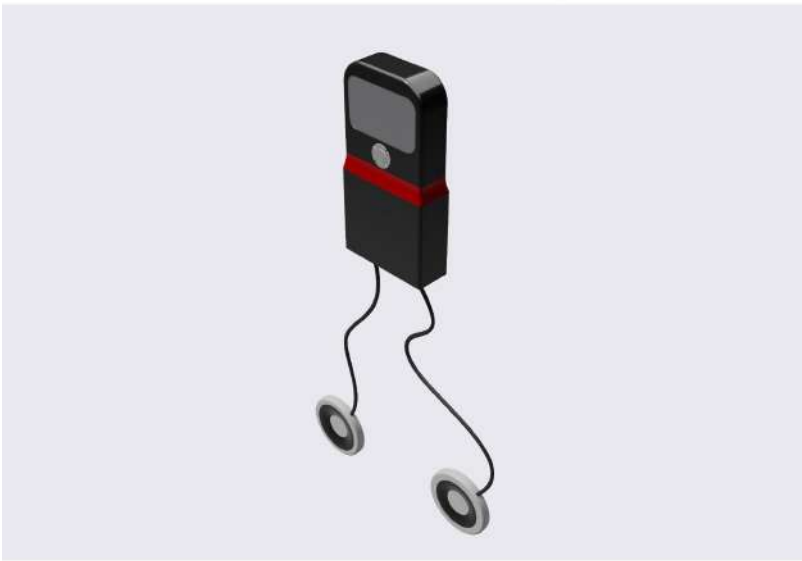



Intellectual Property Office is an operating name of the Patent Office

www.gov.uk/ipo



Intellectual
Property
Office

Certificate of Registration for a UK Design

Design number: 6303706

Grant date: 24 August 2023

Registration date: 15 August 2023

This is to certify that,

in pursuance of and subject to the provision of Registered Designs Act 1949, the design of which a representation or specimen is attached, had been registered as of the date of registration shown above in the name of

Dr. Senthil Kumar Jagatheesan, Dr. Hridayanand Singh, Rouful Alam Bhat, Ms.

Rupali Madhukar Barhate, Mr. Jagatjit Das , Ms. Vaishnavi Balu Raskar, Mr.

Swapnil Kailash Gorde, Dr. Sadhana R Shahi, Sonam Bhutia, Dr. Ankit Jain ,

Amar Kumar Maheshbhai Raval

in respect of the application of such design to:

Non-invasive device for glucose monitoring in diabetic patients

International Design Classification:

Version: 14-2023

Class: 24 MEDICAL AND LABORATORY EQUIPMENT

Subclass: 01 APPARATUS AND EQUIPMENT FOR DOCTORS, HOSPITALS
AND LABORATORIES

Adam Williams

Comptroller-General of Patents, Designs and Trade Marks
Intellectual Property Office

The attention of the Proprietor(s) is drawn to the important notes overleaf.



Representation of Designs









Intellectual Property Office is an operating name of the Patent Office

www.gov.uk/ipo



Intellectual
Property
Office

Certificate of Registration for a UK Design

Design number: 6307009

Grant date: 09 September 2023

Registration date: 01 September 2023

This is to certify that,

in pursuance of and subject to the provision of Registered Designs Act 1949, the design of which a representation or specimen is attached, had been registered as of the date of registration shown above in the name of

Dr.Ashish Kumar Sarangi, Dr.Himansu Bhusan Samal, Dr.Fahima Dilnawaz,

Dr.Kalpita Bhatta

in respect of the application of such design to:

Laparoscopic Instruments

International Design Classification:

Version: 14-2023

Class: 24 MEDICAL AND LABORATORY EQUIPMENT

Subclass: 02 MEDICAL INSTRUMENTS, INSTRUMENTS AND TOOLS FOR LABORATORY USE

Adam Williams

Comptroller-General of Patents, Designs and Trade Marks

Intellectual Property Office

The attention of the Proprietor(s) is drawn to the important notes overleaf.



Representation of Designs





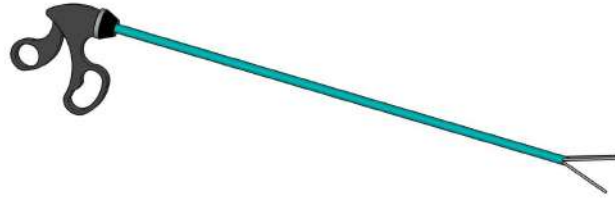

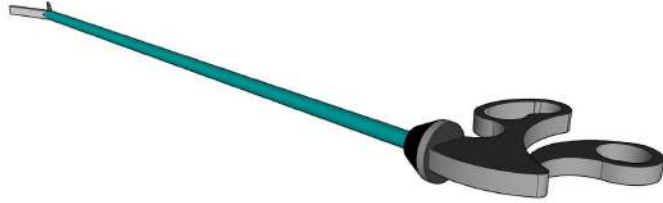

Intellectual Property Office is an operating name of the Patent Office

www.gov.uk/ipo



Intellectual
Property
Office

Certificate of Registration for a UK Design

Design number: 6300181

Grant date: 08 August 2023

Registration date: 29 July 2023

This is to certify that,

in pursuance of and subject to the provision of Registered Designs Act 1949, the design of which a representation or specimen is attached, had been registered as of the date of registration shown above in the name of

Prof. (Dr.) Seema Tomar , Dr.Nasyam Mohammed Akram, Dr. Shaveta Ahalwat,

Mr. Sonu Dewaji Gathe, Dr. Thoppalada. Yunus Pasha, Ajay Kumar Verma, Dr.

Swati Gupta, Dr. Gyanranjan Mahalik, Dr. Annu Mudgal, Ms.Praneetha

Visampalli

in respect of the application of such design to:

DOUBLE DISTILLATION APPARATUS FOR SEPARATION OF ORGANIC

COMPOUNDS

International Design Classification:

Version: 14-2023

Class: 24 MEDICAL AND LABORATORY EQUIPMENT

Subclass: 02 MEDICAL INSTRUMENTS, INSTRUMENTS AND TOOLS FOR LABORATORY USE

Adam Williams

Comptroller-General of Patents, Designs and Trade Marks

Intellectual Property Office

The attention of the Proprietor(s) is drawn to the important notes overleaf.



Representation of Designs

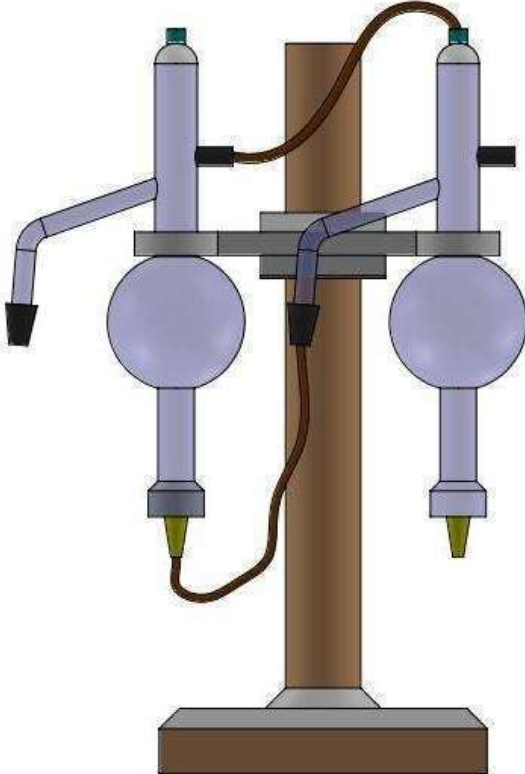
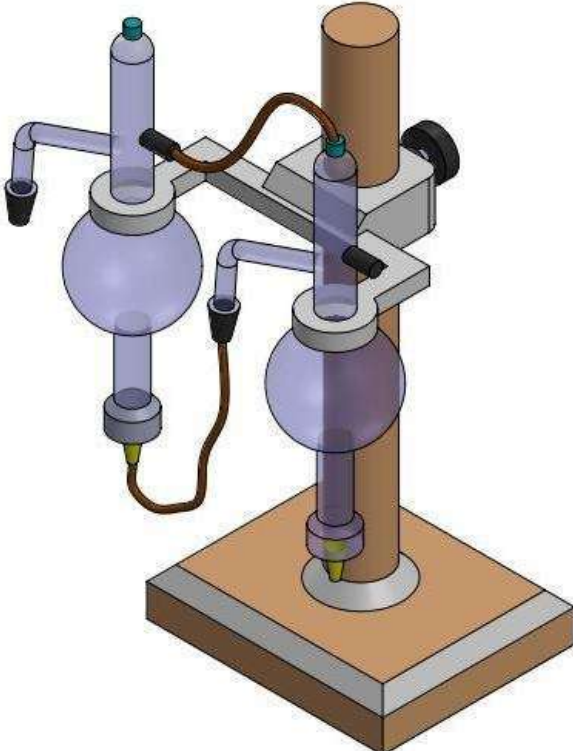

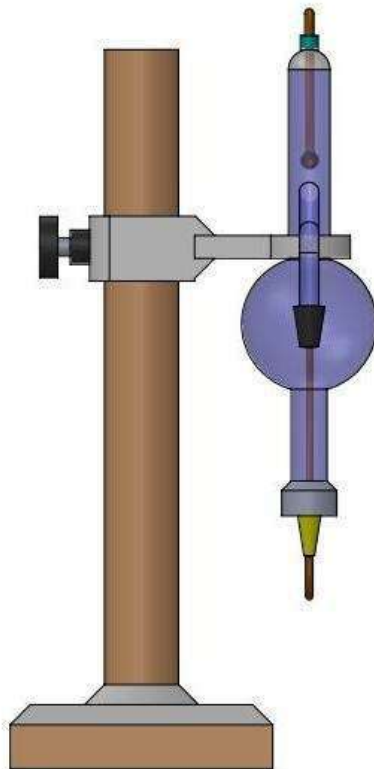
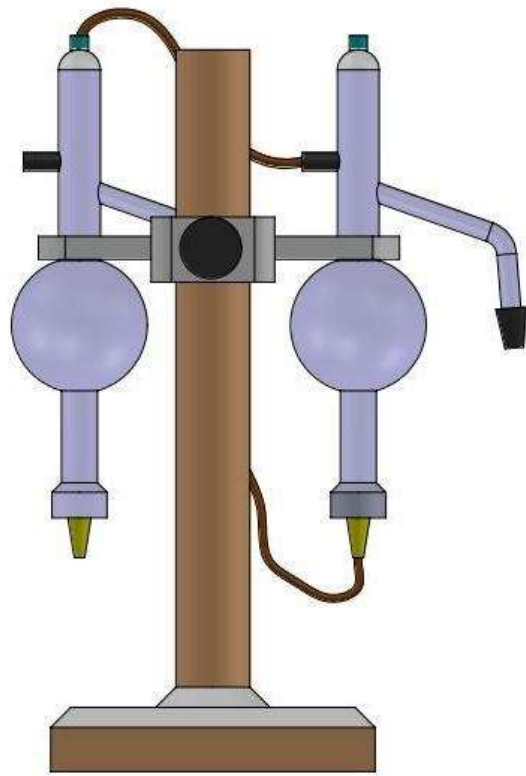

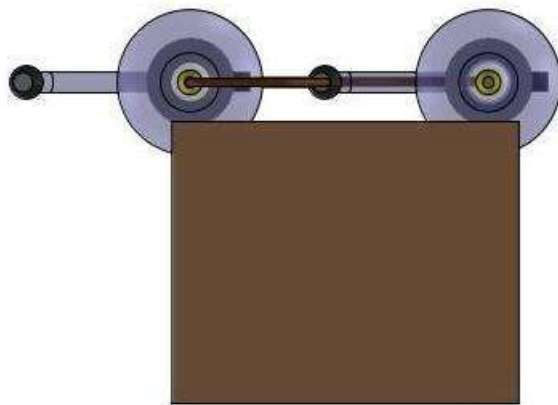
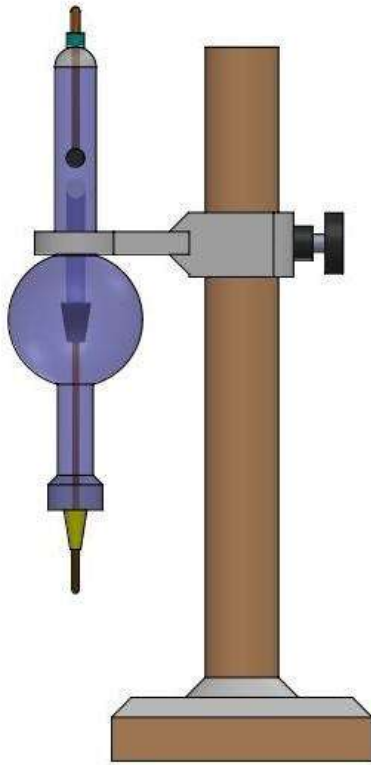

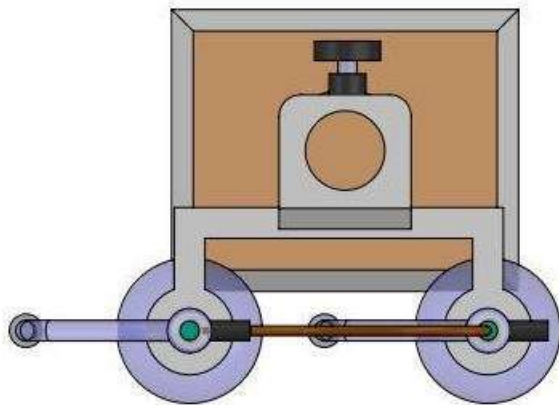

Intellectual Property Office is an operating name of the Patent Office

www.gov.uk/ipo



Intellectual
Property
Office

Certificate of Registration for a UK Design

Design number: 6308140

Grant date: 13 September 2023

Registration date: 06 September 2023

This is to certify that,

in pursuance of and subject to the provision of Registered Designs Act 1949, the design of which a representation or specimen is attached, had been registered as of the date of registration shown above in the name of

Mr. Kundavaram Raju, Dr. Vimal Kumar Shanmugavelu, Mr. Bhaskar Jyoti

Pathak, Mrs. Divyanshi Kothari, Dr. Mohammad Wais, Dr. Mohd Mazhar, Mr.

Azad Nabilal Dhage, Mr. Kartikey Pandey, Mr. Rakesh Meher, Mr. Shatrughna

Uttam Nagrik

in respect of the application of such design to:

Portable Device Used for Measuring cystic fibrosis through Saliva

International Design Classification:

Version: 14-2023

Class: 24 MEDICAL AND LABORATORY EQUIPMENT

Subclass: 02 MEDICAL INSTRUMENTS, INSTRUMENTS AND TOOLS FOR LABORATORY USE

Adam Williams

Comptroller-General of Patents, Designs and Trade Marks
Intellectual Property Office

The attention of the Proprietor(s) is drawn to the important notes overleaf.



Representation of Designs

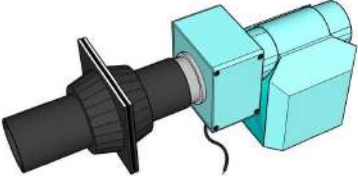
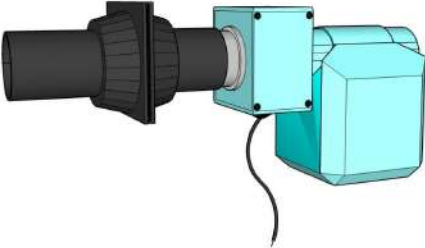

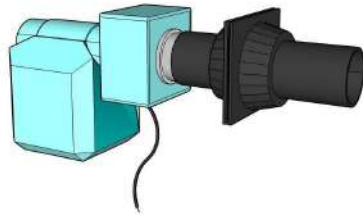
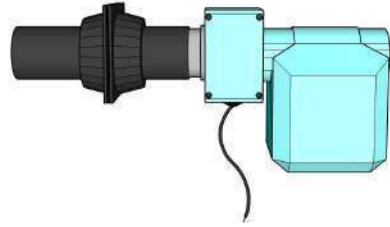

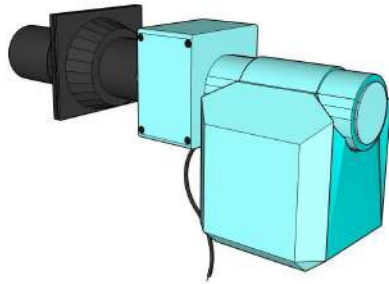
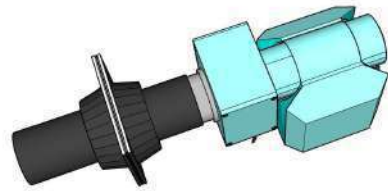

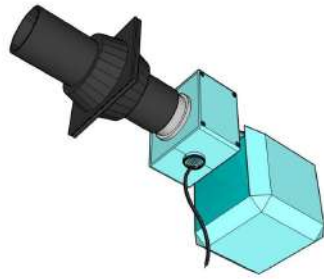

Intellectual Property Office is an operating name of the Patent Office

www.gov.uk/ipo



ORIGINAL
क्रम सं/ Serial No. : 143649



पेटेंट कार्यालय, भारत सरकार | The Patent Office, Government Of India

डिजाइन के पंजीकरण का प्रमाण पत्र | Certificate of Registration of Design

डिजाइन सं. / Design No. : 388845-001

तारीख / Date : 22/06/2023

पारस्परिकता तारीख / Reciprocity Date* :

देश / Country :

प्रमाणित किया जाता है कि संलग्न प्रति में वर्णित डिजाइन जो **SOLAR POWERED DEVICE TO TRACK NUTRIENTS IN AGRI**

WATER से संबंधित है, का पंजीकरण, श्रेणी 10-05 में 1.Dr.Bijaya Bijeta Nayak 2. Dr. Shiv Sankar Das 3.Ms. Debashree Debadatta Behera 4.Dr.Akankshya Patnaik 5.Dr.Kshitish Kumar Khuntia 6.Mr. Satya Prakash Lenka के नाम में उपर्युक्त संख्या और तारीख में कर लिया गया है।

Certified that the design of which a copy is annexed hereto has been registered as of the number and date given above in class 10-05 in respect of the application of such design to **SOLAR POWERED DEVICE TO TRACK NUTRIENTS IN AGRI**

WATER in the name of 1.Dr.Bijaya Bijeta Nayak 2. Dr. Shiv Sankar Das 3.Ms. Debashree Debadatta Behera 4.Dr.Akankshya Patnaik 5.Dr.Kshitish Kumar Khuntia 6.Mr. Satya Prakash Lenka.

डिजाइन अधिनियम, 2000 तथा डिजाइन नियम, 2001 के अधधीन प्रावधानों के अनुसरण में।

In pursuance of and subject to the provisions of the Designs Act, 2000 and the Designs Rules, 2001.

जारी करने की तिथि : 12/09/2023
Date of Issue



(Signature)

महानियंत्रक पेटेंट, डिजाइन और व्यापार चिह्न
Controller General of Patents, Designs and Trade Marks

*पारस्परिकता तारीख (यदि कोई हो) जिसकी अनुमति दी गई है तथा देश का नाम। डिजाइन का स्वत्वाधिकार पंजीकरण की तारीख से दस वर्षों के लिए होगा जिसका विस्तार, अधिनियम एवं नियम के निबंधनों के अधीन, पाँच वर्षों की अतिरिक्त अवधि के लिए किया जा सकेगा। इस प्रमाण पत्र का उपयोग विधिक कार्यवाहियों अथवा विदेश में पंजीकरण प्राप्त करने के लिए नहीं हो सकता है।

The reciprocity date (if any) which has been allowed and the name of the country. Copyright in the design will subsist for ten years from the date of Registration, and may under the terms of the Act and Rules, be extended for a further period of five years. This Certificate is not for use in legal proceedings or for obtaining registration abroad.



ORIGINAL
क्रम सं/ Serial No. : 144763



पेटेंट कार्यालय, भारत सरकार

The Patent Office, Government Of India

डिजाइन के पंजीकरण का प्रमाण पत्र | Certificate of Registration of Design

डिजाइन सं. / Design No. : 392546-001

तारीख / Date : 11/08/2023

पारस्परिकता तारीख / Reciprocity Date* :

देश / Country :

प्रमाणित किया जाता है कि संलग्न प्रति में वर्णित डिजाइन जो **INFRARED BASED MEDICAL DEVICE USED FOR CANCER THERAPY** से संबंधित है, का पंजीकरण, श्रेणी 24-01 में 1.Dr. Ashish Ashok Gawai 2. Dr. Sanjib Das 3.Dr. K. R. Biyani 4.Sachin Ashok Dhawale 5.Dr. Velayutham Suresh 6.Shaik.Munwar 7.Mr. Jagatjit Das 8.Dr. D. Swathi 9.Dr. Dasari Vasavi Devi 10.Ms. Rupali M. Barhate के नाम में उपर्युक्त संख्या और तारीख में कर लिया गया है।

Certified that the design of which a copy is annexed hereto has been registered as of the number and date given above in class 24-01 in respect of the application of such design to **INFRARED BASED MEDICAL DEVICE USED FOR CANCER THERAPY** in the name of 1.Dr. Ashish Ashok Gawai 2. Dr. Sanjib Das 3.Dr. K. R. Biyani 4.Sachin Ashok Dhawale 5.Dr. Velayutham Suresh 6.Shaik.Munwar 7.Mr. Jagatjit Das 8.Dr. D. Swathi 9.Dr. Dasari Vasavi Devi 10.Ms. Rupali M. Barhate.

डिजाइन अधिनियम, 2000 तथा डिजाइन नियम, 2001 के अधधीन प्रावधानों के अनुसरण में।
In pursuance of and subject to the provisions of the Designs Act, 2000 and the Designs Rules, 2001.

जारी करने की तिथि : 27/09/2023
Date of Issue



महानियंत्रक पेटेंट, डिजाइन और व्यापार चिह्न
Controller General of Patents, Designs and Trade Marks

*पारस्परिकता तारीख (यदि कोई हो) जिसकी अनुमति दी गई है तथा देश का नाम। डिजाइन का स्वत्वाधिकार पंजीकरण की तारीख से दस वर्षों के लिए होगा जिसका विस्तार, अधिनियम एवं नियम के निबंधनों के अधीन, पाँच वर्षों की अतिरिक्त अवधि के लिए किया जा सकेगा। इस प्रमाण पत्र का उपयोग विधिक कार्यवाहियों अथवा विदेश में पंजीकरण प्राप्त करने के लिए नहीं हो सकता है।

The reciprocity date (if any) which has been allowed and the name of the country. Copyright in the design will subsist for ten years from the date of Registration, and may under the terms of the Act and Rules, be extended for a further period of five years. This Certificate is not for use in legal proceedings or for obtaining registration abroad.



Intellectual
Property
Office

Certificate of Registration for a UK Design

Design number: 6310504

Grant date: 23 September 2023

Registration date: 14 September 2023

This is to certify that,

in pursuance of and subject to the provision of Registered Designs Act 1949, the design of which a representation or specimen is attached, had been registered as of the date of registration shown above in the name of

Prof. (Dr.) Varsha Deva, Razique Anwer, Shoeb Mustafa, Saif Ahmed, Seema

Paragannavar, Dr Chakrapani Ramesh, Dr. Soumya Jal, Binapani Barik, Dr.

Harshal Ashok Pawar, Dr Vashisth Pankajkumar Bhavsar

in respect of the application of such design to:

Device to detect anticancer activity of coumarin derivatives

International Design Classification:

Version: 14-2023

Class: 24 MEDICAL AND LABORATORY EQUIPMENT

Subclass: 01 APPARATUS AND EQUIPMENT FOR DOCTORS, HOSPITALS
AND LABORATORIES

Adam Williams

Comptroller-General of Patents, Designs and Trade Marks

Intellectual Property Office

The attention of the Proprietor(s) is drawn to the important notes overleaf.



Representation of Designs

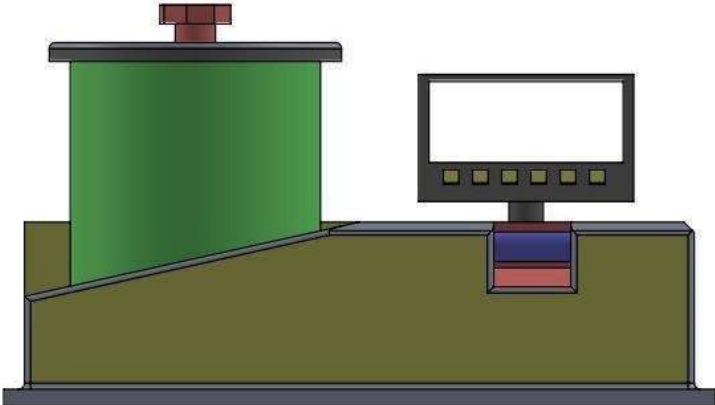
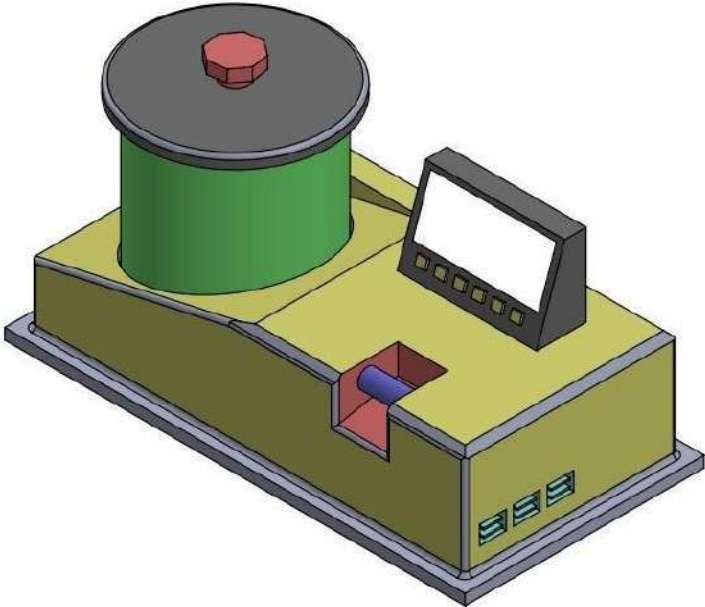

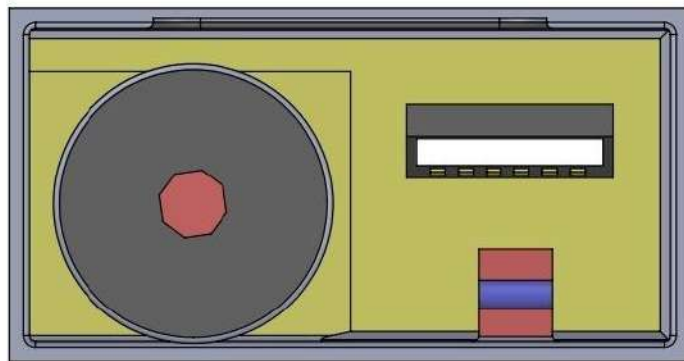
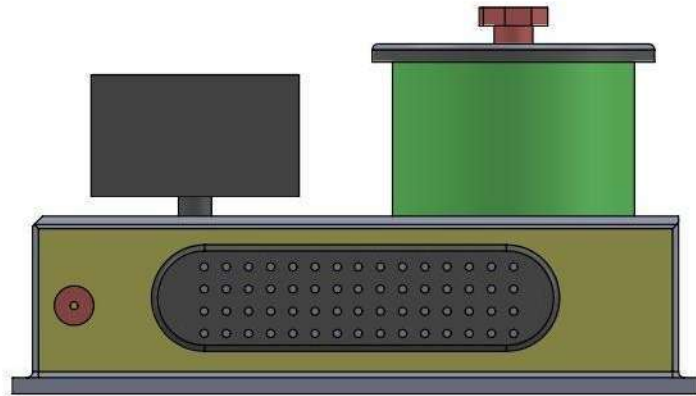

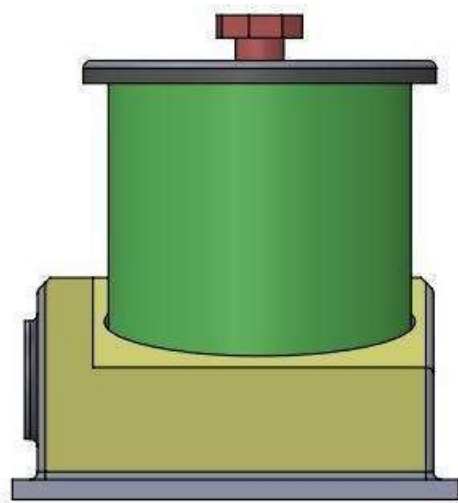

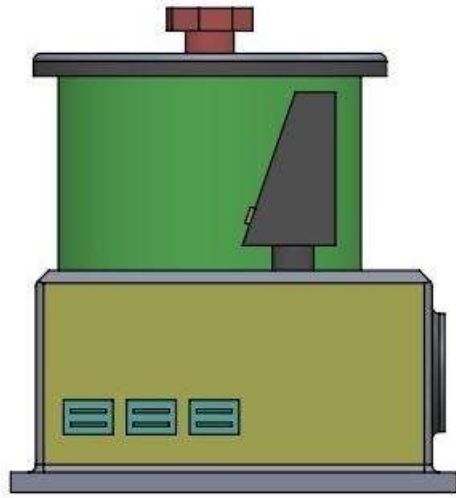

Intellectual Property Office is an operating name of the Patent Office

www.gov.uk/ipo



Intellectual
Property
Office

Certificate of Registration for a UK Design

Design number: 6316607

Grant date: 10 October 2023

Registration date: 03 October 2023

This is to certify that,

in pursuance of and subject to the provision of Registered Designs Act 1949, the design of which a representation or specimen is attached, had been registered as of the date of registration shown above in the name of

Mr. Abhinav Anand, Mr. Suman Kumar Mekap, Dr. Sandhya Subhadra,

Kuchibhotla Phani Sarada Praneetha , Sabita Sahoo, Satyabrata Jena, Ms.

Neelam Kumari , Dr. Daisy Sharma

in respect of the application of such design to:

ELECTROCONVULSIOMETER APPARATUS

International Design Classification:

Version: 14-2023

Class: 24 MEDICAL AND LABORATORY EQUIPMENT

Subclass: 01 APPARATUS AND EQUIPMENT FOR DOCTORS, HOSPITALS
AND LABORATORIES

Adam Williams

Comptroller-General of Patents, Designs and Trade Marks

Intellectual Property Office

The attention of the Proprietor(s) is drawn to the important notes overleaf.



Intellectual Property Office is an operating name of the Patent Office

www.gov.uk/ipo

Representation of Designs

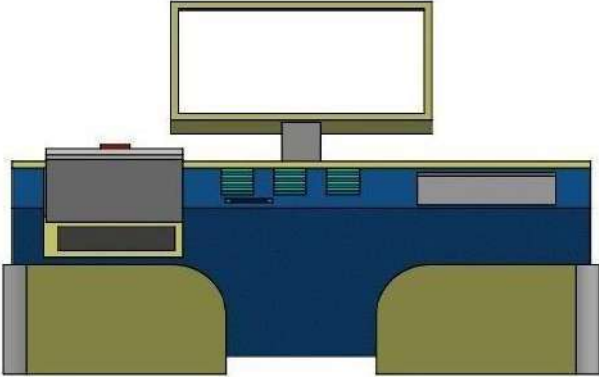
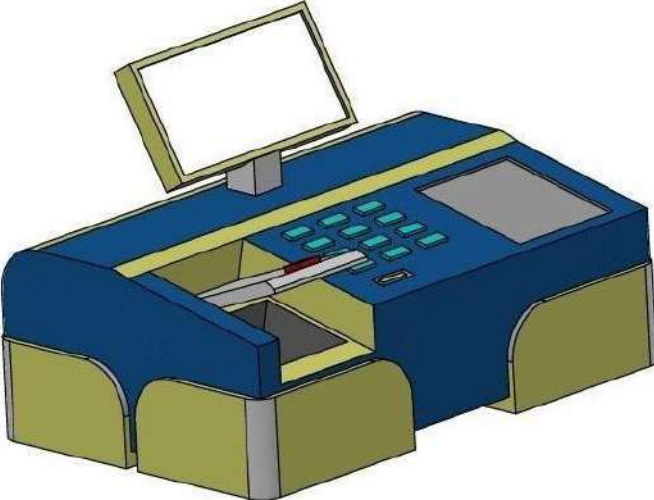

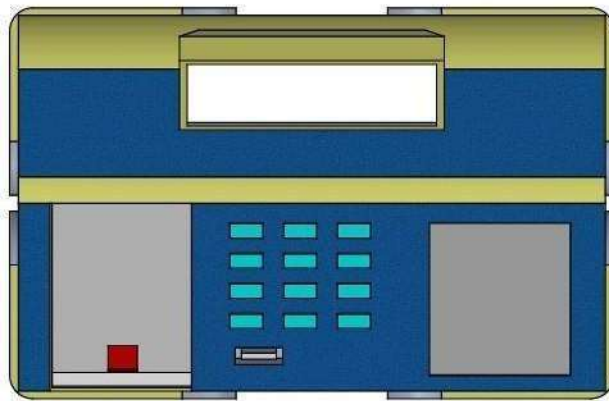
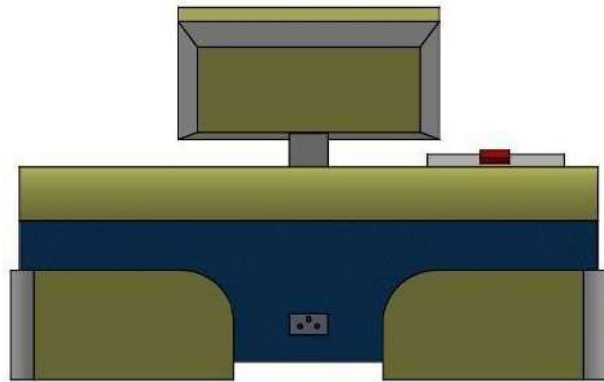

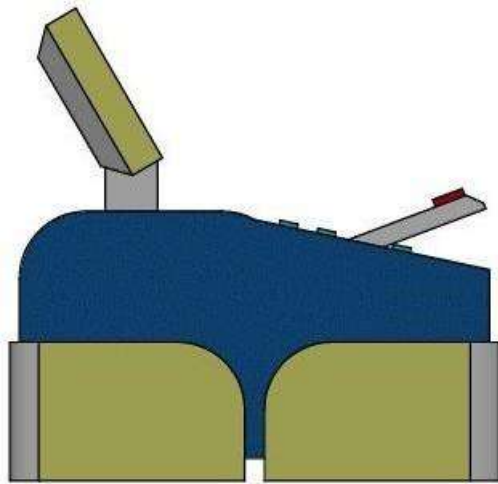
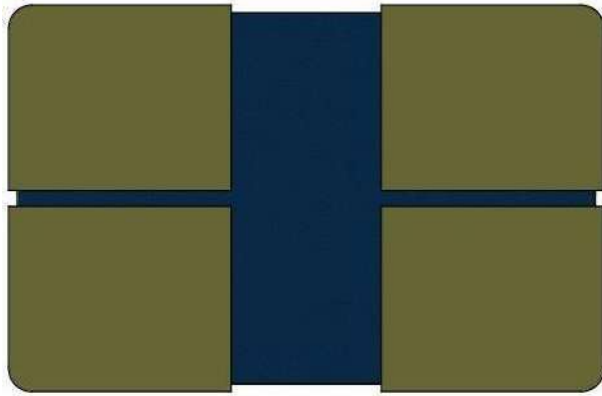

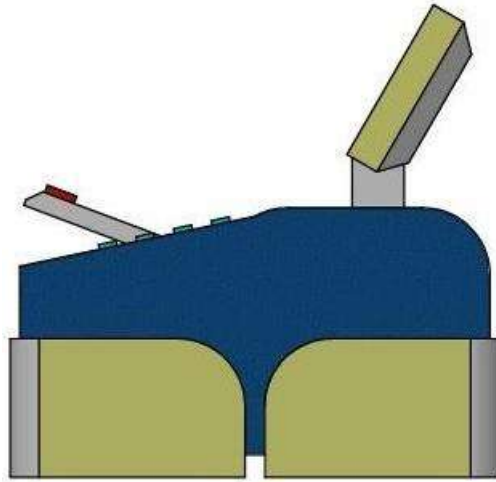

Intellectual Property Office is an operating name of the Patent Office

www.gov.uk/ipo



ORIGINAL
क्रम सं/ Serial No. : 143530



पेटेंट कार्यालय, भारत सरकार | The Patent Office, Government Of India

डिजाइन के पंजीकरण का प्रमाण पत्र | Certificate of Registration of Design

डिजाइन सं. / Design No. : 388222-001

तारीख / Date : 13/06/2023

पारस्परिकता तारीख / Reciprocity Date* :

देश / Country :

प्रमाणित किया जाता है कि संलग्न प्रति में वर्णित डिजाइन जो **DISSOLUTION APPARATUS FOR SOLID DOSAGE FORM** से संबंधित है, का पंजीकरण, श्रेणी 24-01 में 1.Dr. Ram Singh Bishnoi 2. Dr. Y. Ankamma Chowdary 3. Mayuresh Kashinath Raut 4. Himanshu Sharma 5. Dr. Mukesh Kumar Gupta 6. Annanya Gangopadhyay 7. Dr. Yudhishter Singh Bagal 8. Poonam Maurya 9. Dr. Prabhakar Vishvakarma 10. Suraj Mandal के नाम में उपर्युक्त संख्या और तारीख में कर लिया गया है।

Certified that the design of which a copy is annexed hereto has been registered as of the number and date given above in class 24-01 in respect of the application of such design to **DISSOLUTION APPARATUS FOR SOLID DOSAGE FORM** in the name of 1. Dr. Ram Singh Bishnoi 2. Dr. Y. Ankamma Chowdary 3. Mayuresh Kashinath Raut 4. Himanshu Sharma 5. Dr. Mukesh Kumar Gupta 6. Annanya Gangopadhyay 7. Dr. Yudhishter Singh Bagal 8. Poonam Maurya 9. Dr. Prabhakar Vishvakarma 10. Suraj Mandal.

डिजाइन अधिनियम, 2000 तथा डिजाइन नियम, 2001 के अधधीन प्रावधानों के अनुसरण में।

In pursuance of and subject to the provisions of the Designs Act, 2000 and the Designs Rules, 2001.

जारी करने की तिथि : 06/09/2023
Date of Issue



(Signature)

महानियंत्रक पेटेंट, डिजाइन और व्यापार चिह्न
Controller General of Patents, Designs and Trade Marks

*पारस्परिकता तारीख (यदि कोई हो) जिसकी अनुमति दी गई है तथा देश का नाम। डिजाइन का स्वत्वाधिकार पंजीकरण की तारीख से दस वर्षों के लिए होगा जिसका विस्तार, अधिनियम एवं नियम के निबंधनों के अधीन, पाँच वर्षों की अतिरिक्त अवधि के लिए किया जा सकेगा। इस प्रमाण पत्र का उपयोग विधिक कार्यवाहियों अथवा विदेश में पंजीकरण प्राप्त करने के लिए नहीं हो सकता है।
The reciprocity date (if any) which has been allowed and the name of the country. Copyright in the design will subsist for ten years from the date of Registration, and may under the terms of the Act and Rules, be extended for a further period of five years. This Certificate is not for use in legal proceedings or for obtaining registration abroad.



ORIGINAL
क्रम सं/ Serial No. : 144858



पेटेंट कार्यालय, भारत सरकार

The Patent Office, Government Of India

डिजाइन के पंजीकरण का प्रमाण पत्र | Certificate of Registration of Design

डिजाइन सं. / Design No. : 392900-001

तारीख / Date : 17/08/2023

पारस्परिकता तारीख / Reciprocity Date* :

देश / Country :

प्रमाणित किया जाता है कि संलग्न प्रति में वर्णित डिजाइन जो **INFRARED TRACKING LIGHT USED FOR CANCER THERAPY** से संबंधित है, का पंजीकरण, श्रेणी 24-01 में 1.Dr. Imran Ataurrahman Sheikh 2. Mrs. Sarbani Biswas Das 3.Mr. Vishwadeepak Kimothi 4.Dr. Sharmistha Chakraborty 5.Dr. Amit Joshi 6.Dr. Namrata Suri 7.Mr. Prachet Bagewadikar 8.Mrs. Annanya Gangopadhyay के नाम में उपर्युक्त संख्या और तारीख में कर लिया गया है।

Certified that the design of which a copy is annexed hereto has been registered as of the number and date given above in class 24-01 in respect of the application of such design to **INFRARED TRACKING LIGHT USED FOR CANCER THERAPY** in the name of 1.Dr. Imran Ataurrahman Sheikh 2. Mrs. Sarbani Biswas Das 3.Mr. Vishwadeepak Kimothi 4.Dr. Sharmistha Chakraborty 5.Dr. Amit Joshi 6.Dr. Namrata Suri 7.Mr. Prachet Bagewadikar 8.Mrs. Annanya Gangopadhyay.

डिजाइन अधिनियम, 2000 तथा डिजाइन नियम, 2001 के अध्याधीन प्रावधानों के अनुसरण में।

In pursuance of and subject to the provisions of the Designs Act, 2000 and the Designs Rules, 2001.

जारी करने की तिथि : 27/09/2023
Date of Issue



महानियंत्रक पेटेंट, डिजाइन और व्यापार चिह्न
Controller General of Patents, Designs and Trade Marks

*पारस्परिकता तारीख (यदि कोई हो) जिसकी अनुमति दी गई है तथा देश का नाम। डिजाइन का स्वत्वाधिकार पंजीकरण की तारीख से दस वर्षों के लिए होगा जिसका विस्तार, अधिनियम एवं नियम के निबंधनों के अधीन, पाँच वर्षों की अतिरिक्त अवधि के लिए किया जा सकेगा। इस प्रमाण पत्र का उपयोग विधिक कार्यवाहियों अथवा विदेश में पंजीकरण प्राप्त करने के लिए नहीं हो सकता है।
The reciprocity date (if any) which has been allowed and the name of the country. Copyright in the design will subsist for ten years from the date of Registration, and may under the terms of the Act and Rules, be extended for a further period of five years. This Certificate is not for use in legal proceedings or for obtaining registration abroad.



Intellectual
Property
Office

Certificate of Registration for a UK Design

Design number: 6314868

Grant date: 03 October 2023

Registration date: 23 September 2023

This is to certify that,

in pursuance of and subject to the provision of Registered Designs Act 1949, the design of which a representation or specimen is attached, had been registered as of the date of registration shown above in the name of

Dr. Ram Kumar Choudhary, Gireesh Tripathi, Dr. Chitra Karthikeyini Senthivel,

Dr. Om Mahadeo Bagade, Dr. Anil Ahuja, Ms. Rashmi Bagri, Dr. Vipul

Trikambhai Prajapati, Mr. Shantilal Pitaram Padhiyar, Mr. Ashish Kumar Meher,

Dr. Parag Arun Kulkarni, Dr. Tejas Babubhai Patel

in respect of the application of such design to:

Reciprocating type dissolution apparatus for Controlled release dosage forms

International Design Classification:

Version: 14-2023

Class: 24 MEDICAL AND LABORATORY EQUIPMENT

Subclass: 01 APPARATUS AND EQUIPMENT FOR DOCTORS, HOSPITALS
AND LABORATORIES

Adam Williams

Comptroller-General of Patents, Designs and Trade Marks
Intellectual Property Office

The attention of the Proprietor(s) is drawn to the important notes overleaf.



Representation of Designs

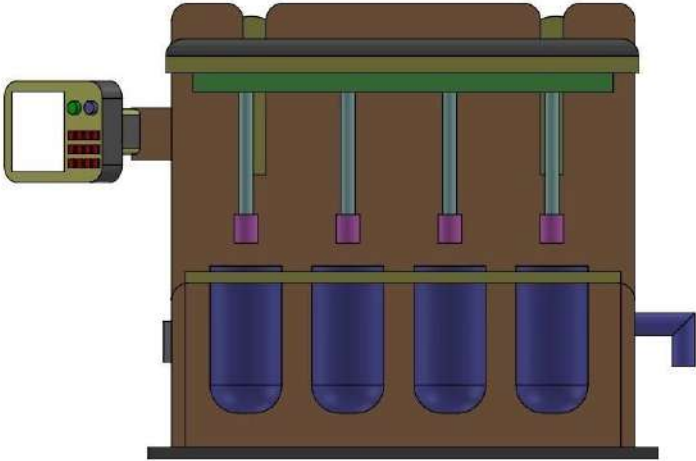
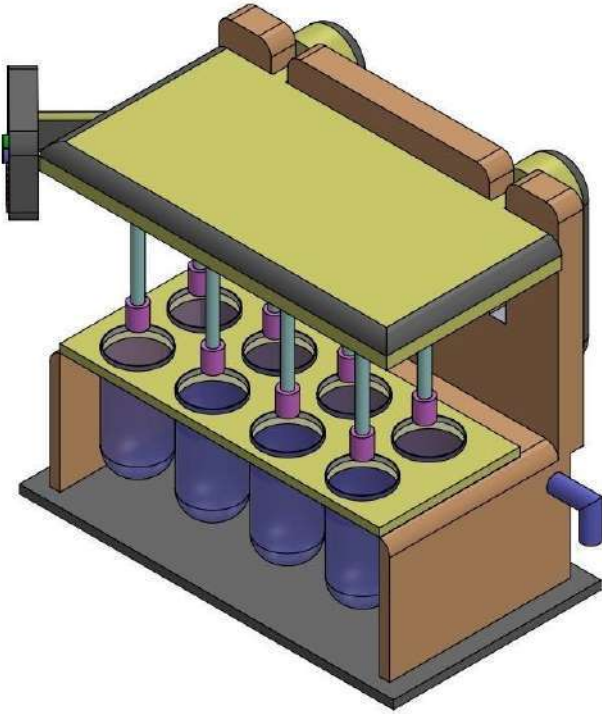

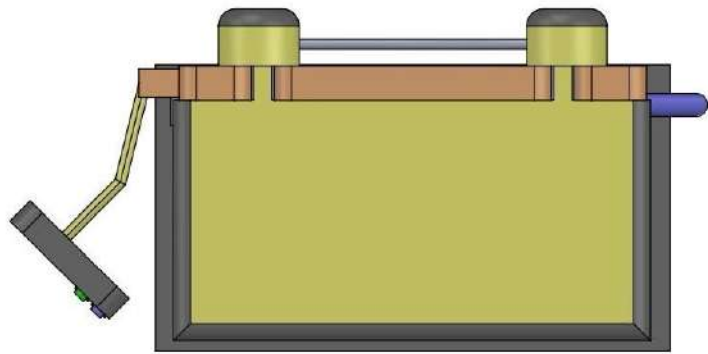
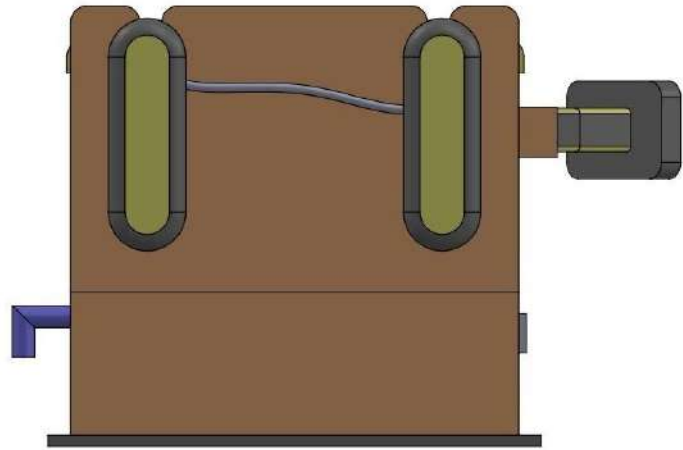

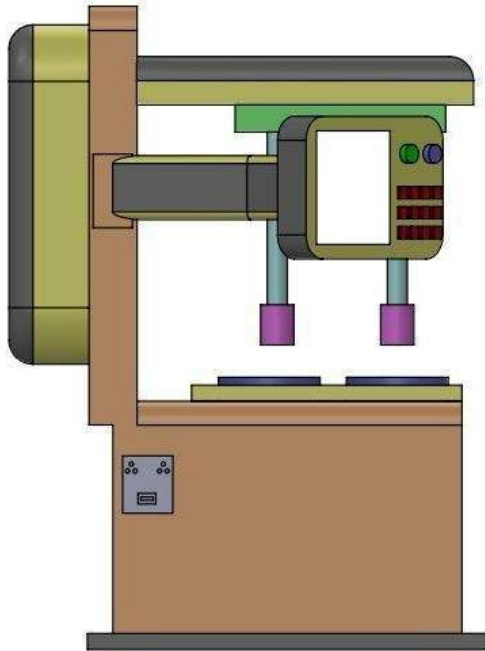
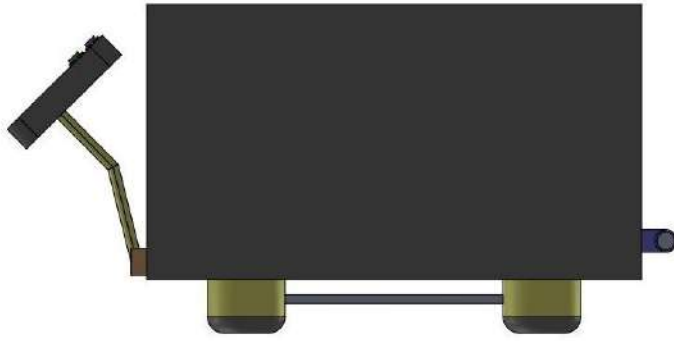

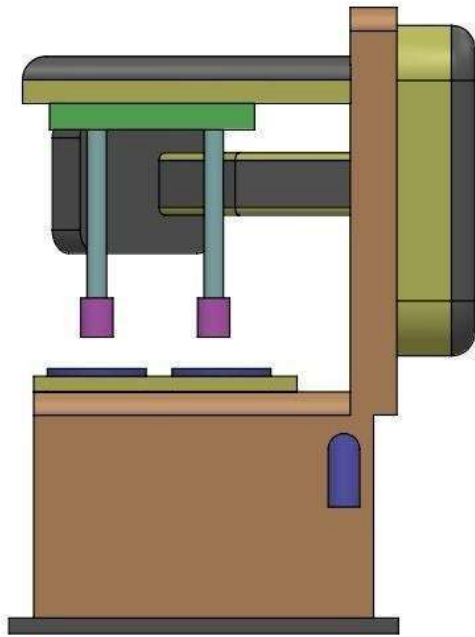

Intellectual Property Office is an operating name of the Patent Office

www.gov.uk/ipo



Intellectual
Property
Office

Certificate of Registration for a UK Design

Design number: 6311028

Grant date: 25 September 2023

Registration date: 18 September 2023

This is to certify that,

in pursuance of and subject to the provision of Registered Designs Act 1949, the design of which a representation or specimen is attached, had been registered as of the date of registration shown above in the name of

Dr. Kumara Prasad Sonangeri Annu Rai, Dr. Senthil Rajan Dharmalingam, Dr.

Senthil Kumar Marimuthu, Dr. Saroj Yadav, Dr. Grandhi Srikar, Ms. Binapani

Barik, Sathwara Shivani Girishbhai, Dr. Tejas Babubhai Patel, Dr. Amit Ambalal

Patel, Dr. Ravish Janakbhai Patel, Dr. Naga Prashant Koppuravuri

in respect of the application of such design to:

Franz diffusion apparatus for permeability and stability studies of topical

formulations

International Design Classification:

Version: 14-2023

Class: 24 MEDICAL AND LABORATORY EQUIPMENT

Subclass: 01 APPARATUS AND EQUIPMENT FOR DOCTORS, HOSPITALS
AND LABORATORIES

Adam Williams

Comptroller-General of Patents, Designs and Trade Marks

Intellectual Property Office

The attention of the Proprietor(s) is drawn to the important notes overleaf.





Intellectual
Property
Office

Certificate of Registration for a UK Design

Design number: 6309595

Grant date: 19 September 2023

Registration date: 09 September 2023

This is to certify that,

in pursuance of and subject to the provision of Registered Designs Act 1949, the design of which a representation or specimen is attached, had been registered as of the date of registration shown above in the name of

Mr. Pranshul Sethi, Prof. (Dr.) Varsha Deva, Masa. Amala, Dr. Shikha Pandey,

Dr. Venkata Suresh Chinni, Dr. Shmmon Ahmad, Dr. Ghulam Md Ashraf, Dr.

Sonja Jose, Biswajeet Acharya, Dr. Prafulla Adkarpatil

in respect of the application of such design to:

AI Enabled Medical Device for Detection of Neurological Disorders

International Design Classification:

Version: 14-2023

Class: 24 MEDICAL AND LABORATORY EQUIPMENT

Subclass: 01 APPARATUS AND EQUIPMENT FOR DOCTORS, HOSPITALS
AND LABORATORIES

Adam Williams

Comptroller-General of Patents, Designs and Trade Marks

Intellectual Property Office

The attention of the Proprietor(s) is drawn to the important notes overleaf.



Representation of Designs

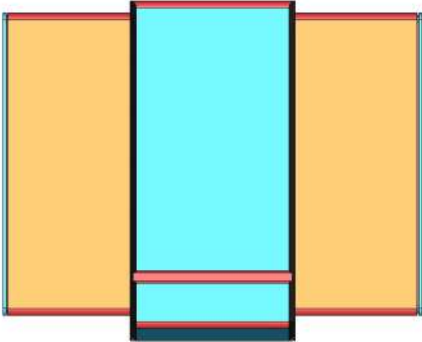
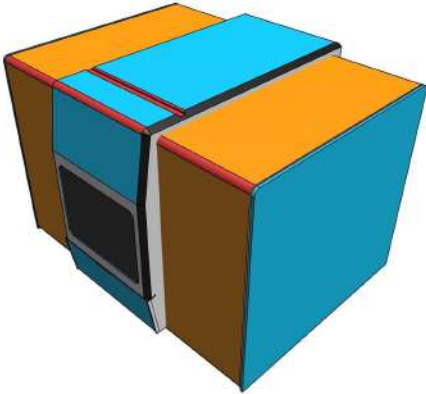

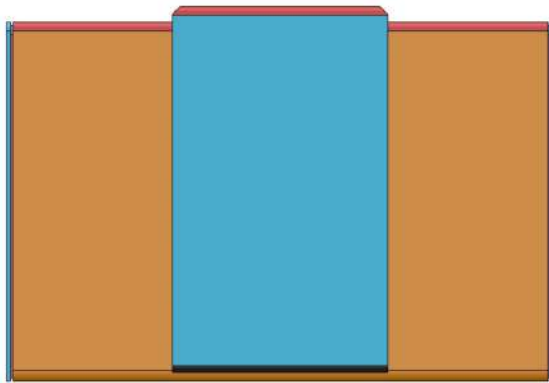
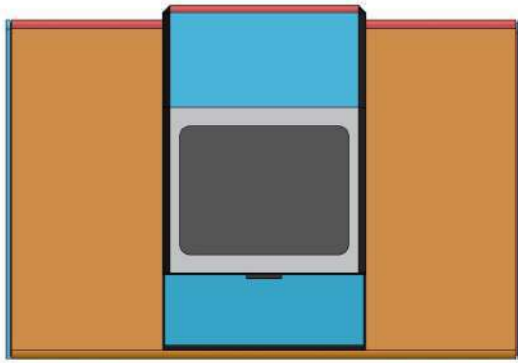





Intellectual
Property
Office

Certificate of Registration for a UK Design

Design number: 6326159

Grant date: 23 November 2023

Registration date: 15 November 2023

This is to certify that,

in pursuance of and subject to the provision of Registered Designs Act 1949, the design of which a representation or specimen is attached, had been registered as of the date of registration shown above in the name of

Dr Seelam Ramya Krishna, Mr. Pund Amol Rajendra, Prof. Abhijit Anil Gaikwad,

Dr. R.C Mishra, Dr. Barrawaz Aateka Yahya, Mr. Ladi Alik Kumar, Mr. Dheeraj,

Mr. Yogendra, Ms. Priya Sharma, Dr. Imran Ataurrahman Sheikh

in respect of the application of such design to:

Apparatus use to Separate Protein as Per Molecular Size

International Design Classification:

Version: 14-2023

Class: 24 MEDICAL AND LABORATORY EQUIPMENT

Subclass: 02 MEDICAL INSTRUMENTS, INSTRUMENTS AND TOOLS FOR LABORATORY USE

Adam Williams

Comptroller-General of Patents, Designs and Trade Marks

Intellectual Property Office

The attention of the Proprietor(s) is drawn to the important notes overleaf.



Representation of Designs

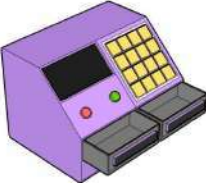

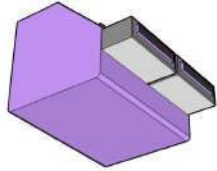





Intellectual Property Office is an operating name of the Patent Office

www.gov.uk/ipo



Intellectual
Property
Office

Certificate of Registration for a UK Design

Design number: 6319522

Grant date: 24 October 2023

Registration date: 17 October 2023

This is to certify that,

in pursuance of and subject to the provision of Registered Designs Act 1949, the design of which a representation or specimen is attached, had been registered as of the date of registration shown above in the name of

Dr. Amer Ahmed Syed, Mr. Mahesh Kumar Yadav, Mr. Amit Rajendrakumar

Jaiswal, Mr. Alok Bihari Das, Dr. Calvin Ronchen Wei, Dr. Shahrukh Irfan, Mr.

Satish Siripini, Dr. Ladli Kishore, Dr. Deepak Sharma, Mr. Nageswar Panda

in respect of the application of such design to:

MEDICAL DEVICE FOR FACILITATING REMOTE MEDICAL EXAMINATION

International Design Classification:

Version: 14-2023

Class: 24 MEDICAL AND LABORATORY EQUIPMENT

Subclass: 01 APPARATUS AND EQUIPMENT FOR DOCTORS, HOSPITALS
AND LABORATORIES

Adam Williams

Comptroller-General of Patents, Designs and Trade Marks

Intellectual Property Office

The attention of the Proprietor(s) is drawn to the important notes overleaf.





Intellectual
Property
Office

Certificate of Registration for a UK Design

Design number: 6293410

Grant date: 10 July 2023

Registration date: 30 June 2023

This is to certify that,

in pursuance of and subject to the provision of Registered Designs Act 1949, the design of which a representation or specimen is attached, had been registered as of the date of registration shown above in the name of

Dr. Lavanya Yaidikar, Dr.Palayyan Muralidharan, Mr. Shashikant Sudarshan

Upadhye, Dr. Damarasingu Prasanth , Dr. Sanjeshkumar Gotam rathi , Dr.

Maulikkumar Dineshbhai Vaja , Mr. Abhishek Shrivastava, Dr. Sagar Pamu,

Patel Mineshkumar Ashvinkumar, Heenaben Abhishek Chokshi

in respect of the application of such design to:

T- Maze device for Detection of Locomotor activity in animals

International Design Classification:

Version: 14-2023

Class: 30 ARTICLES FOR THE CARE AND HANDLING OF ANIMALS

Subclass: 02 PENS, CAGES, KENNELS AND SIMILAR SHELTERS

Adam Williams

Comptroller-General of Patents, Designs and Trade Marks

Intellectual Property Office

The attention of the Proprietor(s) is drawn to the important notes overleaf.



Representation of Designs

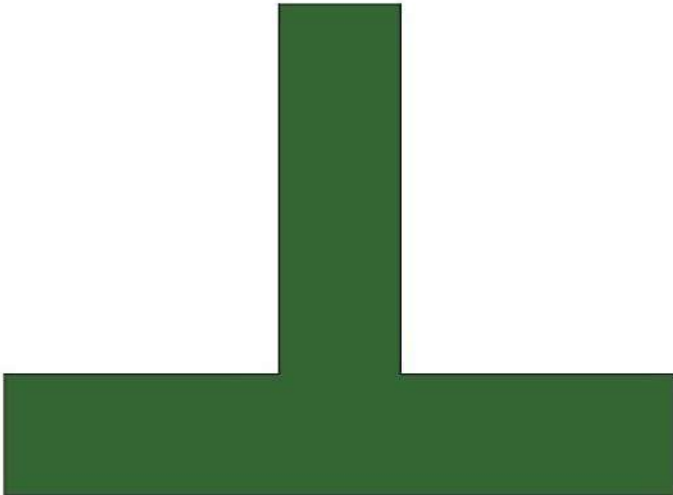
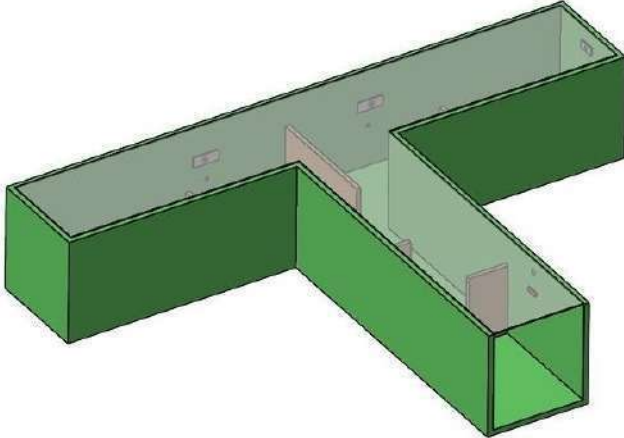

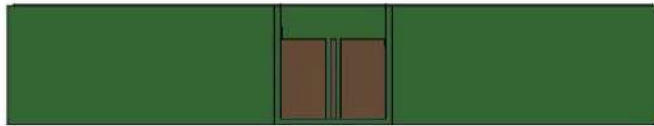
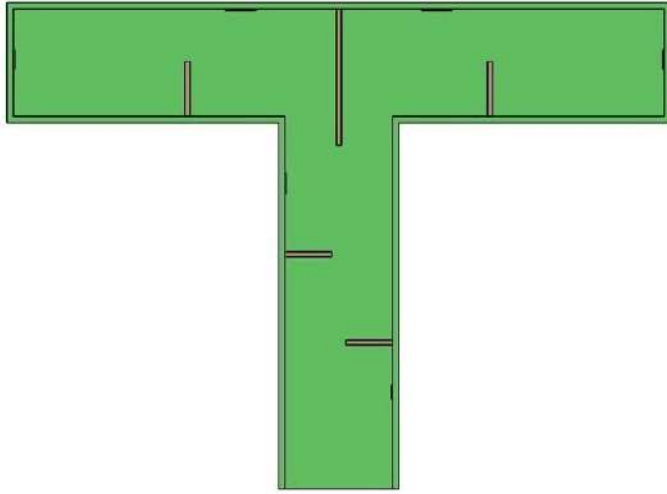





Intellectual Property Office is an operating name of the Patent Office

www.gov.uk/ipo



Intellectual
Property
Office

Certificate of Registration for a UK Design

Design number: 6273618

Grant date: 17 April 2023

Registration date: 05 April 2023

This is to certify that,

in pursuance of and subject to the provision of Registered Designs Act 1949, the design of which a representation or specimen is attached, had been registered as of the date of registration shown above in the name of

Dr.Ashish Kumar Sarangi, Dr.Rudra Narayan Sahoo, Dr.Kalpita Bhatta,

Ms.Rasmita Dash

in respect of the application of such design to:

COVID testing machine with digital display

International Design Classification:

Version: 14-2023

Class: 24 MEDICAL AND LABORATORY EQUIPMENT

Subclass: 01 APPARATUS AND EQUIPMENT FOR DOCTORS, HOSPITALS
AND LABORATORIES

Adam Williams

Comptroller-General of Patents, Designs and Trade Marks

Intellectual Property Office

The attention of the Proprietor(s) is drawn to the important notes overleaf.



Representation of Designs

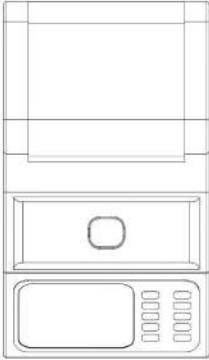
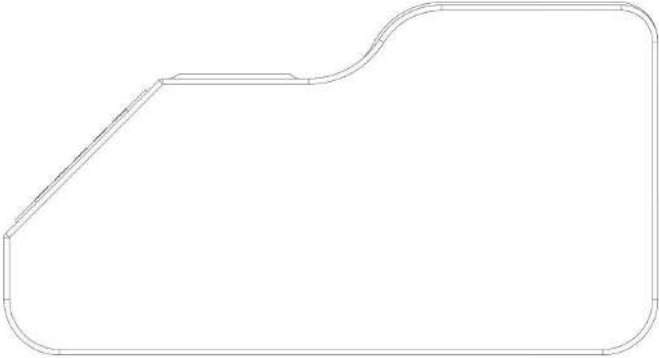

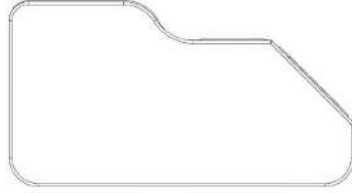

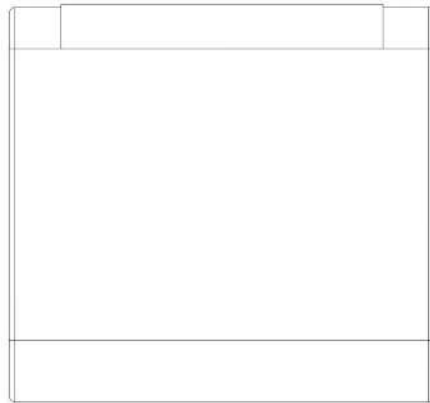
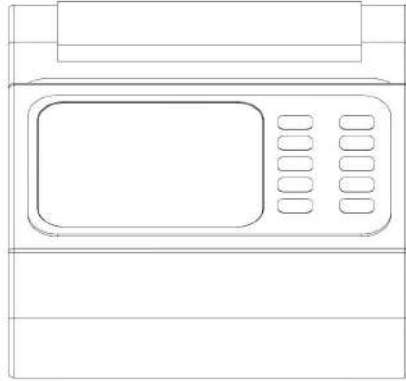



Intellectual
Property
Office

Certificate of Registration for a UK Design

Design number: 6323558

Grant date: 14 November 2023

Registration date: 03 November 2023

This is to certify that,

in pursuance of and subject to the provision of Registered Designs Act 1949, the design of which a representation or specimen is attached, had been registered as of the date of registration shown above in the name of

Mr. Kundavaram Raju, Dr. Kolanpaka Blessi Priyanka, Mr. Shubham Maroti

Shende, Ms. Nidhi Saxena, Mr. Sanjeeb Kumar Sahoo, Ms. Shadma Wahab, Dr.

Chetan Ram, Mr. Mandhare Shubham Bhausahab, Dr. Manoj Prabhakar

Shirbhate, Mrs. Sarbani Biswas Das

in respect of the application of such design to:

Fully Automatic Centrifuge Machine used for Phase Separation

International Design Classification:

Version: 14-2023

Class: 24 MEDICAL AND LABORATORY EQUIPMENT

Subclass: 01 APPARATUS AND EQUIPMENT FOR DOCTORS, HOSPITALS
AND LABORATORIES

Adam Williams

Comptroller-General of Patents, Designs and Trade Marks
Intellectual Property Office

The attention of the Proprietor(s) is drawn to the important notes overleaf.



Representation of Designs



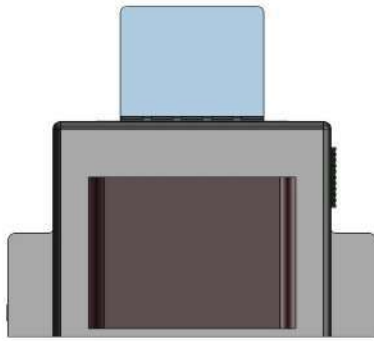

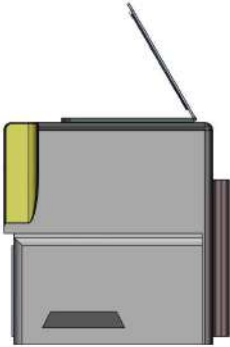
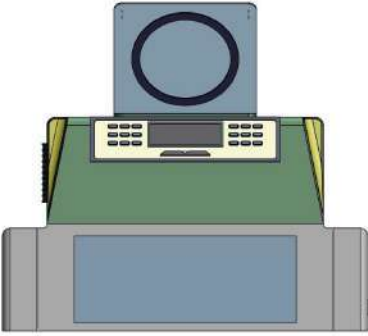

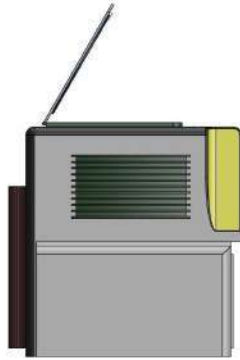

Intellectual Property Office is an operating name of the Patent Office

www.gov.uk/ipo



ORIGINAL
क्रम सं/ Serial No. : 142942



पेटेंट कार्यालय, भारत सरकार | The Patent Office, Government Of India

डिजाइन के पंजीकरण का प्रमाण पत्र | Certificate of Registration of Design

डिजाइन सं. / Design No. : 385545-001

तारीख / Date : 04/05/2023

पारस्परिकता तारीख / Reciprocity Date* :

देश / Country :

प्रमाणित किया जाता है कि संलग्न प्रति में वर्णित डिजाइन जो **LIGHTWEIGHT PORTABLE SUCTION PUMP PHARMACEUTICAL LABORATORY** से संबंधित है, का पंजीकरण, श्रेणी 24-02 में 1.Dr. Girendra Kumar Gautam 2. Dr. Dimak Chand Sahu 3.Ms. Meenakshi Jaiswal 4.Dr. Vikas Chandra Sharma 5.Dr. Satendra Kumar 6.Dr. Virendra Kumar Patel 7.Ms. Nidhi Agrawal 8.Mr. Vijaya Kumar Meher 9.Dr. Amit Joshi 10.Ms. Niharika Thakur के नाम में उपर्युक्त संख्या और तारीख में कर लिया गया है।

Certified that the design of which a copy is annexed hereto has been registered as of the number and date given above in class 24-02 in respect of the application of such design to **LIGHTWEIGHT PORTABLE SUCTION PUMP PHARMACEUTICAL LABORATORY** in the name of 1.Dr. Girendra Kumar Gautam 2. Dr. Dimak Chand Sahu 3.Ms. Meenakshi Jaiswal 4.Dr. Vikas Chandra Sharma 5.Dr. Satendra Kumar 6.Dr. Virendra Kumar Patel 7.Ms. Nidhi Agrawal 8.Mr. Vijaya Kumar Meher 9.Dr. Amit Joshi 10.Ms. Niharika Thakur.

डिजाइन अधिनियम, 2000 तथा डिजाइन नियम, 2001 के अधधीन प्रावधानों के अनुसरण में।

In pursuance of and subject to the provisions of the Designs Act, 2000 and the Designs Rules, 2001.

जारी करने की तिथि : 31/08/2023
Date of Issue



(Signature)

महानियंत्रक पेटेंट, डिजाइन और व्यापार चिह्न
Controller General of Patents, Designs and Trade Marks

*पारस्परिकता तारीख (यदि कोई हो) जिसकी अनुमति दी गई है तथा देश का नाम। डिजाइन का स्वत्वाधिकार पंजीकरण की तारीख से दस वर्षों के लिए होगा जिसका विस्तार, अधिनियम एवं नियम के निबंधनों के अधीन, पाँच वर्षों की अतिरिक्त अवधि के लिए किया जा सकेगा। इस प्रमाण पत्र का उपयोग विधिक कार्यवाहियों अथवा विदेश में पंजीकरण प्राप्त करने के लिए नहीं हो सकता है।

The reciprocity date (if any) which has been allowed and the name of the country. Copyright in the design will subsist for ten years from the date of Registration, and may under the terms of the Act and Rules, be extended for a further period of five years. This Certificate is not for use in legal proceedings or for obtaining registration abroad.



ORIGINAL

क्रम सं/ Serial No. : 153677



पेटेंट कार्यालय, भारत सरकार The Patent Office, Government Of India

डिजाइन के पंजीकरण का प्रमाण पत्र | Certificate of Registration of Design

डिजाइन सं. / Design No. : 398800-001

तारीख / Date : 30/10/2023

पारस्परिकता तारीख / Reciprocity Date* :

देश / Country :

प्रमाणित किया जाता है कि संलग्न प्रति में वर्णित डिजाइन जो DEVICE FOR DETECTION OF ACTIVE CONSTITUENTS FROM MEDICINAL PLANTS से संबंधित है, का पंजीकरण, श्रेणी 10-05 में 1.Neha Verma 2. Dr Snehal Chakorkar 3.Nigar Kadar Mujawar 4.Manvi Singh 5.Dr Mithun Maniyar 6.Dr Himansu Bhusan Samal 7.Revati Tatyasaheb Deore 8.Dr Nitin Narayan Hire 9.Rekha Pathak 10.Anand Kumar के नाम में उपर्युक्त संख्या और तारीख में कर लिया गया है।

Certified that the design of which a copy is annexed hereto has been registered as of the number and date given above in class 10-05 in respect of the application of such design to DEVICE FOR DETECTION OF ACTIVE CONSTITUENTS FROM MEDICINAL PLANTS in the name of 1.Neha Verma 2. Dr Snehal Chakorkar 3.Nigar Kadar Mujawar 4.Manvi Singh 5.Dr Mithun Maniyar 6.Dr Himansu Bhusan Samal 7.Revati Tatyasaheb Deore 8.Dr Nitin Narayan Hire 9.Rekha Pathak 10.Anand Kumar.

डिजाइन अधिनियम, 2000 तथा डिजाइन नियम, 2001 के अध्याधीन प्रावधानों के अनुसरण में।

In pursuance of and subject to the provisions of the Designs Act, 2000 and the Designs Rules, 2001.

जारी करने की तिथि : 15/01/2024 Date of Issue



महानियंत्रक पेटेंट, डिजाइन और व्यापार चिह्न Controller General of Patents, Designs and Trade Marks

*पारस्परिकता तारीख (यदि कोई हो) जिसकी अनुमति दी गई है तथा देश का नाम। डिजाइन का स्वत्वाधिकार पंजीकरण की तारीख से दस वर्षों के लिए होगा जिसका विस्तार, अधिनियम एवं नियम के निबंधनों के अधीन, पाँच वर्षों की अतिरिक्त अवधि के लिए किया जा सकेगा। इस प्रमाण पत्र का उपयोग विधिक कार्यवाहियों अथवा विदेश में पंजीकरण प्राप्त करने के लिए नहीं हो सकता है।

The reciprocity date (if any) which has been allowed and the name of the country. Copyright in the design will subsist for ten years from the date of Registration, and may under the terms of the Act and Rules, be extended for a further period of five years. This Certificate is not for use in legal proceedings or for obtaining registration abroad.



ORIGINAL
क्रम सं/ Serial No. : 154145



पेटेंट कार्यालय, भारत सरकार | The Patent Office, Government Of India

डिजाइन के पंजीकरण का प्रमाण पत्र | Certificate of Registration of Design

डिजाइन सं. / Design No. : 399997-001

तारीख / Date : 15/11/2023

पारस्परिकता तारीख / Reciprocity Date* :

देश / Country :

प्रमाणित किया जाता है कि संलग्न प्रति में वर्णित डिजाइन जो **PORTABLE TABLET SPRAY DRYING APPARATUS** से संबंधित है, का पंजीकरण, श्रेणी 15-99 में 1.Neha Verma 2. Nitin Rajan 3.Dr. Mallela Vijaya Jyothi 4.Dr Indrajeet Singhvi 5.Mukesh Tiwari 6.Jagatjit Das 7.Rojalika Mohanty 8.Dr. Himansu Bhusan Samal 9.Dr Rajesh Singh Jadon 10.Dr.Himanshu Kanubhai Solanki के नाम में उपर्युक्त संख्या और तारीख में कर लिया गया है।

Certified that the design of which a copy is annexed hereto has been registered as of the number and date given above in class 15-99 in respect of the application of such design to **PORTABLE TABLET SPRAY DRYING APPARATUS** in the name of 1.Neha Verma 2. Nitin Rajan 3.Dr. Mallela Vijaya Jyothi 4.Dr Indrajeet Singhvi 5.Mukesh Tiwari 6.Jagatjit Das 7.Rojalika Mohanty 8.Dr. Himansu Bhusan Samal 9.Dr Rajesh Singh Jadon 10.Dr.Himanshu Kanubhai Solanki.

डिजाइन अधिनियम, 2000 तथा डिजाइन नियम, 2001 के अधधीन प्रावधानों के अनुसरण में।

In pursuance of and subject to the provisions of the Designs Act, 2000 and the Designs Rules, 2001.

जारी करने की तिथि : 19/01/2024
Date of Issue



महानियंत्रक पेटेंट, डिजाइन और व्यापार चिह्न
Controller General of Patents, Designs and Trade Marks

*पारस्परिकता तारीख (यदि कोई हो) जिसकी अनुमति दी गई है तथा देश का नाम। डिजाइन का स्वत्वाधिकार पंजीकरण की तारीख से दस वर्षों के लिए होगा जिसका विस्तार, अधिनियम एवं नियम के निबंधनों के अधीन, पाँच वर्षों की अतिरिक्त अवधि के लिए किया जा सकेगा। इस प्रमाण पत्र का उपयोग विधिक कार्यवाहियों अथवा विदेश में पंजीकरण प्राप्त करने के लिए नहीं हो सकता है।

The reciprocity date (if any) which has been allowed and the name of the country. Copyright in the design will subsist for ten years from the date of Registration, and may under the terms of the Act and Rules, be extended for a further period of five years. This Certificate is not for use in legal proceedings or for obtaining registration abroad.

REPUBLIC OF SOUTH AFRICA



REPUBLIEK VAN SUID AFRIKA

PATENTS ACT, 1978

CERTIFICATE

In accordance with section 44 (1) of the Patents Act, No. 57 of 1978, it is hereby certified that:

Dr.Ashish Kumar Sarangi; Dr.Rudra Narayan Sahoo; Dr.Gurudutta Pattnaik; Dr.Md Sajid Ali; Dr.Nawazish Alam; Dr.Sarfaraz Ahmad; Dr.Ranjan Kumar Mohapatra; Dr.Sovan Pattanaik

Has been granted a patent in respect of an invention described and claimed in complete specification deposited at the Patent Office under the number

2023/01070

A copy of the complete specification is annexed, together with the relevant Form P2.

In testimony whereof, the seal of the Patent Office has been affixed at Pretoria with effect from the 29th day of March 2023

.....
Registrar of Patents



REPUBLIC OF SOUTH AFRICA
PATENTS ACT, 1978
REGISTER OF PATENTS

FORM P2

Official application No.		Lodging date: Provisional		Acceptance date	
21	01 2023/01070	22		47	6 March 2023
International classification		Lodging date: National phase		Granted date	
51	C12Q	23	25 January 2023		29 March 2023
71	Full name(s) of applicant(s)/Patentee(s):				
	(1) Dr.Ashish Kumar Sarangi; (2) Dr.Rudra Narayan Sahoo; (3) Dr.Gurudutta Pattnaik; (4) Dr.Md Sajid Ali; (5) Dr.Nawazish Alam; (6) Dr.Sarfaraz Ahmad; (7) Dr.Ranjan Kumar Mohapatra; (8) Dr.Sovan Pattanaik				
71	Applicant(s) substituted:			Date registrered	
71	Assignee(s):			Date registrered	
72	Full name(s) of inventor(s):				
	(1) Dr.Ashish Kumar Sarangi; (2) Dr.Rudra Narayan Sahoo; (3) Dr.Gurudutta Pattnaik; (4) Dr.Md Sajid Ali; (5) Dr.Nawazish Alam; (6) Dr.Sarfaraz Ahmad; (7) Dr.Ranjan Kumar Mohapatra; (8) Dr.Sovan Pattanaik				
Priority claimed:	Country	Number	Date		
	IN	202231071013	9 December 2022		
54	Title of invention				
	A SYSTEM FOR CANCER DETECTION AND MONITORING USING CUSTOMIZED DETECTION OF CIRCULATING DNA AND METHOD THEREOF				
	Address of applicant(s)/patentee(s):				
	(1) Assistant Professor, Department of Chemistry, School of Applied Science, Centurion University of Technology and Management, Balangir, Odisha, Balangir, Odisha, 767001, India; (2) Assistant Professor, School of Pharmacy and Life Sciences, Centurion University of Technology and Management,, Bhubaneswar, Bhubaneswar, Odisha, 752050, India; (3) Professor, School of Pharmacy and Life Sciences, Centurion University of Technology and Management,, Khordha, Khordha, Odisha, 752050, India; (4) Assistant Professor, Department of Pharmaceutics, College of Pharmacy, Jazan University, Jazan, Kingdom of Saudi Arabia., Jazan, Jazan, Jazan, 45142, Saudi Arabia; (5) Assistant Professor, Department of Pharmacy Practice, College of Pharmacy, Jazan University,, Jazan, Jazan, Jazan, 45142, Saudi Arabia; (6) Lecturer, Department of Pharmacy Practice, College of Pharmacy, Jazan University,, Jazan, Jazan, Jazan, 45142, Saudi Arabia; (7) Department of Chemistry, Government College of Engineering,, Keonjhar, Keonjhar, Odisha, 758002, India; (8) School of Pharmaceutical Sciences, Siksha O Anusandhan Deemed to be University, Kalinga Nagar, Bhubaneswar, Bhubaneswar, Odisha, 751003, India				
74	Address for service				
	Sibanda and Zantwijk, Oaktree Corner, 9 Kruger Street, Oaklands (PO Box 1615 Houghton 2041), Johannesburg, 2192, SOUTH AFRICA Reference no.: PT_CP_ZA00007212 ([InsID:])				
61	Patent of addition No.		Date of any change		
	Fresh application based on.		Date of any change		

REPUBLIC OF SOUTH AFRICA
PATENTS ACT, 1978
COMPLETE SPECIFICATION
[Section 30(1) - Regulation 28]

FORM P7

OFFICIAL APPLICATION NO.

21	01	2023/01070
----	----	------------

LOGGING DATE

22	25 January 2023
----	-----------------

INTERNATIONAL CLASSIFICATION

51	C12Q
----	------

FULL NAME(S) OF APPLICANT(S)

71	Dr.Ashish Kumar Sarangi Dr.Rudra Narayan Sahoo Dr.Gurudutta Pattnaik Dr.Md Sajid Ali Dr.Nawazish Alam Dr.Sarfaraz Ahmad Dr.Ranjan Kumar Mohapatra Dr.Sovan Pattanaik
----	---

FULL NAME(S) OF INVENTORS(S)

72	Dr.Ashish Kumar Sarangi Dr.Rudra Narayan Sahoo Dr.Gurudutta Pattnaik Dr.Md Sajid Ali Dr.Nawazish Alam Dr.Sarfaraz Ahmad Dr.Ranjan Kumar Mohapatra Dr.Sovan Pattanaik
----	---

TITLE OF INVENTION

54	A SYSTEM FOR CANCER DETECTION AND MONITORING USING CUSTOMIZED DETECTION OF CIRCULATING DNA AND METHOD THEREOF
----	---

TITLE OF THE INVENTION

A SYSTEM FOR CANCER DETECTION AND MONITORING USING CUSTOMIZED DETECTION OF CIRCULATING DNA AND METHOD THEREOF

FIELD OF THE INVENTION

[001] The present invention relates to the field of the cancer detection with novel techniques, methods and apparatus. The invention more particularly relates to a system for cancer detection and monitoring using customized
5 detection of circulating DNA and method thereof.

BACKGROUND OF THE INVENTION

[002] The following description provides the information that may be useful in understanding the present invention. It is not an admission that any of the information provided herein is prior art or relevant to the presently claimed
10 invention, or that any publication specifically or implicitly referenced is prior art.

[003] Further, the approaches described in this section are approaches that could be pursued, but not necessarily approaches that have been previously conceived or pursued. Therefore, unless otherwise indicated, it should not be
15 assumed that any of the approaches described in this section qualify as prior art merely by virtue of their inclusion in this section.

[004] The identification of particular genetic changes in circulating DNA or RNA is the basis of several scholarly or patent papers that suggest strategies for cancer detection. In theory, in order to achieve an adequate amount of
20 information, the approaches for the molecular characterisation of gene

changes have low sensitivity and necessitate the examination of a sizable panel of gene markers. A technique for quantifying circulating naked DNA in plasma from lung cancer patients has recently been disclosed. It is based on a colorimetric assay that can distinguish between patients and healthy participants and can quickly identify the disease's recurrence during follow-up (Sozzi, G. et al., Cancer Research 61, 4675-4678, Jun. 15, 2001). However, a restricted linearity in the range of 0.1–10 ng/ml and reduced sensitivity to lower levels limit the use of colorimetric techniques (such as DNA Dipstick) for the quantitative measurement of circulating DNA. Additionally, the exam reading makes use of judgement.

[005] Accordingly, on the basis of aforesaid facts, there remains a need in the prior art to provide a system for cancer detection and monitoring using customized detection of circulating DNA and method thereof. The proposed system overcomes the problem of conventional and complex techniques, and which have the potential of accelerating through the various intelligent modules. Therefore, it would be useful and desirable to have a system, method, apparatus and interfaces to meet the above-mentioned needs.

SUMMARY OF THE PRESENT INVENTION

[006] In view of the foregoing disadvantages inherent in the known types of conventional systems, methods and techniques for cancer detection, are now present in the prior art, the present invention provides a system for cancer detection and monitoring using customized detection of circulating DNA and method thereof, which has all the advantages of the prior art and none of the disadvantages.

[007] It is an object of the present invention, to provide a method of providing the nucleic acid from a peripheral blood sample obtained from the subject; contacting the nucleic acid with at least a first primer in conditions that will amplify the BRAF gene or a portion of it, if the BRAF gene is present in the peripheral blood sample; and a processing device for determining whether the BRAF gene or a portion of it has a mutation in comparison to a wild-type BRAF sequence.

[008] In addition, a means for taking a plasma sample from the BRAF gene, separating the DNA there, and adding it to the target DNA sample, which contains a set of oligonucleotide primers appropriate for PCR amplification of a segment of the human telomerase reverse transcriptase (BRAF) gene.

[009] In this respect, before explaining at least one object of the invention in detail, it is to be understood that the invention is not limited in its application to the details of set of rules and to the arrangements of the various models set forth in the following description or illustrated in the drawings. The invention is capable of other objects and of being practiced and carried out in various ways, according to the need of that industry. Also, it is to be understood that the phraseology and terminology employed herein are for the purpose of description and should not be regarded as limiting.

[010] These together with other objects of the invention, along with the various features of novelty which characterize the invention, are pointed out with particularity in the disclosure. For a better understanding of the invention, its operating advantages and the specific objects attained by its uses, reference should be made to the accompanying drawings and descriptive matter in which there are illustrated preferred embodiments of the invention.

BRIEF DESCRIPTION OF THE DRAWINGS

5 [011] When considering the following thorough explanation of the present invention, it will be easier to understand it and other objects than those mentioned above will become evident. Such description refers to the illustrations in the annex, wherein:

[012] **FIG. 1**, illustrates a schematic diagram of a system for cancer detection and monitoring using customized detection of circulating DNA and method thereof, in accordance with an embodiment of the present invention.

10 [013] **FIG. 2**, illustrates another schematic diagram of the system for cancer detection and monitoring using customized detection of circulating DNA and method thereof, in accordance with an embodiment of the present invention.

DETAILED DESCRIPTION OF THE INVENTION

15 [014] The following sections of this article will provide various embodiments of the current invention with references to the accompanying drawings, whereby the reference numbers utilised in the picture correspond to like elements throughout the description. However, this invention is not limited to the embodiment described here and may be embodied in several other ways. Instead, the embodiment is included to ensure that this disclosure is extensive and complete and that individuals of ordinary skill in the art are properly
20 informed of the extent of the invention. Numerical values and ranges are given for many parts of the implementations discussed in the following thorough discussion. These numbers and ranges are merely to be used as examples and are not meant to restrict the claims' applicability. A variety of materials are also recognised as fitting for certain aspects of the implementations. These

materials should only be used as examples and are not meant to restrict the application of the innovation.

[015] Referring now to the drawings, these are illustrated in FIG. 1 & 2, the present invention discloses a system for cancer detection and monitoring using customized detection of circulating DNA and method thereof. The system is comprised of, but not limited to, a means for supplying the nucleic acid from a peripheral blood sample taken from the subject; and contacting the nucleic acid with at least a first primer under circumstances that will cause the amplification of the BRAF gene or a fragment of it if the BRAF gene is present in the peripheral blood sample; and a processing device for determining whether the BRAF gene or a fragment of it contains a mutation in comparison to a wild-type BRAF sequence.

[016] In accordance with another embodiment of the present invention, a means for obtaining a plasma sample from the BRAF gene and extracting the DNA therefrom to create a target DNA sample; and adding to the target DNA sample, wherein a combination of oligonucleotide primers suitable for PCR amplification of a fragment of the human telomerase reverse transcriptase (BRAF) gene.

[017] In accordance with another embodiment of the present invention, the fragment of the BRAF gene is from nucleotide position 13059 to nucleotide position 13156 of the amplifying the BRAF gene fragment and include a heat-stable DNA polymerase with 5'-3' exonuclease activity and monitoring the fluorescence that is generated, as shown in figure 2.

[018] In accordance with another embodiment of the present invention, concentration of circulating total DNA in a plasma sample is determined by

quantifying the BRAF copy number, and the BRAF copy number is correlated with the subject's risk of developing cancer.

[019] In accordance with another embodiment of the present invention, quantifying the BRAF gene DNA copy number in the target DNA sample involves extrapolating a calibration curve made with known amounts of DNA and includes comparing the level of circulating DNA to a reference level. a reference concentration of 9 to 25 ng/ml is used.

[020] Further, utilising a histone H3.1, H3.2, H3, or H3t binding agent to identify, separate, and/or purify cell free nucleosomes (CFNs) or circulating tumour DNA (ctDNA) from BRAF gene DNA copy number.

[021] In accordance with another embodiment of the present invention, any gene that is both amplified and over expressed in cancer cells can be measured for gene over expression (RNA) and gene amplification (DNA) in a patient's bodily fluids and compared to healthy controls as part of a method for the diagnosis or monitoring of the progression of cancers.

[022] The above-mentioned invention is provided with the preciseness in its real-world applications to provide a system for cancer detection and monitoring using customized detection of circulating DNA and method thereof. Further, this method involves RNA and DNA being extracted from a bodily fluid, purified, and amplified and the fact that reverse transcriptase chain reaction amplifies the nucleic acids.

[023] The benefits and advantages that the present invention may offer have been discussed above with reference to particular embodiments. These benefits and advantages are not to be interpreted as critical, necessary, or essential features of any or all of the embodiments, nor are they to be read as

any elements or constraints that might contribute to their occurring or becoming more evident.

[024] Although specific embodiments have been used to describe the current invention, it should be recognised that these embodiments are merely illustrative and that the invention is not limited to them. The aforementioned
5 embodiments are open to numerous alterations, additions, and improvements. These adaptations, changes, additions, and enhancements are considered to be within the purview of the invention.

We Claim:

1. A system for cancer detection and monitoring using customized detection of circulating DNA, comprising:
a means for supplying the nucleic acid from a peripheral blood sample taken from the subject; and contacting the nucleic acid with at least a first primer under circumstances that will cause the amplification of the BRAF gene or a fragment of it if the BRAF gene is present in the peripheral blood sample; and a processing device for determining whether the BRAF gene or a fragment of it contains a mutation in comparison to a wild-type BRAF sequence.
2. The system as claimed in claim 1, wherein obtaining a plasma sample from the BRAF gene and extracting the DNA therefrom to create a target DNA sample; and adding to the target DNA sample, wherein a combination of oligonucleotide primers suitable for PCR amplification of a fragment of the human telomerase reverse transcriptase (BRAF) gene.
3. The system as claimed in claim 1, wherein the fragment of the BRAF gene is from nucleotide position 13059 to nucleotide position 13156 of the amplifying the BRAF gene fragment and include a heat-stable DNA polymerase with 5'-3' exonuclease activity and monitoring the fluorescence that is generated.
4. The system as claimed in claim 1, wherein the concentration of circulating total DNA in a plasma sample is determined by quantifying the BRAF copy number, and the BRAF copy number is correlated with the subject's risk of developing cancer.
5. The system as claimed in claim 1, wherein quantifying the BRAF gene DNA copy number in the target DNA sample involves extrapolating a calibration curve made with known amounts of DNA and includes comparing the level of

circulating DNA to a reference level. a reference concentration of 9 to 25 ng/ml is used.

6. The system as claimed in claim 1, wherein utilising a histone H3.1, H3.2, H3, or H3t binding agent to identify, separate, and/or purify cell free nucleosomes (CFNs) or circulating tumour DNA (ctDNA) from BRAF gene DNA copy number.
7. The system as claimed in claim 1, wherein any gene that is both amplified and over expressed in cancer cells can be measured for gene over expression (RNA) and gene amplification (DNA) in a patient's bodily fluids and compared to healthy controls as part of a method for the diagnosis or monitoring of the progression of cancers.
8. The system as claimed in claim 1, wherein this method involves RNA and DNA being extracted from a bodily fluid, purified, and amplified and the fact that reverse transcriptase chain reaction amplifies the nucleic acids.

cgccctccggccccctccccccgcagcagcgccgctcgggccccggctctcggttataagaatggc
ggcgtgagcgggtggcgggtggcggggcggagccgggcccaggctctgttcaacggggacatgga
gcccagccggcggccggcggccggcggccctctcggctcgggacccctgccatccggagga
gggtgggaatcaaaacaaatgattaagtgcacacaggaaatataagaggccctatggacaaat
tgggtggggagcataatccaccatcaatatactggaggccatgaagaatcacccagcaagctaga
tgcactcaacaaaagagaacaacagttatggaaatctctggggaacggaaactgattttctgttct
tagctctgcatcaatggataccgttacctctctctctctctcagcttctcagtgctacctctac
ctcttctcagttttcaaaatccccacagatgtggcacggagcaaccccaagtcaacacaaaacctat
cgttagagtctctctgccccaaaacagaggacagtggtacctcgaaggtgtggagttacagtcog
agacagctcaaaagaaagcactgatgatgagaggctcaatcccagagtctgtgtctgtttacagaat
tcaggatggagagaagaaacaaatgggtgggacactgataatctctggctactggagaagaat
gcatgtggaaagtgtggagaatgtccactcaacacacacaaactttgtacgaaaaacgtttctcac
cttagcaatcttggtaactttgtcgaaagetgtcttccagggttctcogctgtaaaacatgtggtta
aaaattccaccagcgtttagtagcagaagttccactgtatgtgttaattatgaccaacttgatt
gctgtttgtctccaagtctctgaaacaccaccaataaccaaggaagaggcgtcttagcagagac
tgccctaacatctggatcatcccctccgcaccggcctcggactctatggggccccaaatctctac
cagtcogctctctccaaatccatccaaatccacagccctccgacccagagatgaagatcagtc
aaatcaatctgggcaacgagaccgatctctcagctcccaatgtgcataaaacacaatagaacc
tgtcaatattgatgacttgatagagaccaaggattctcgtggtgatggaggatcaacccagagtt
gtctgctacccccctgctctatctcctggctcaactaactaacgtgaaagccttacagaaatctcc
aggacctcagcgaagaaaggaagtcatctctcctcagaagacaggaatcgaatgaaaacacttgg
tagacgggactcagtgatgattgggagatctctgatgggcagatcacagtgggacaaaagaattgg
atctggatcaatgggaacagttcaaaagggaaagtggcattggtgagtggtggcagtgaaaatgtgaa
tgtgacagcactacacctcagcagttacaagcctcaaaaatgaagtaggagtaactcagggaaaac
acgacatgtgaaatcctactctctcagggctattccacaaagcccaactggctattgttaccac
gtggtgtgagggtccagcttgtatcaccatctccatctcattgagacaaaattgagatgataaa
acttatagatattgcacgacagactgcacagggtcaggtacttacacgccaagtcaatcatcca
cagagacctcaagagtaataatataatctctctgatgaagacctcagctaaaaataggatgatttgg
ctagctacagcaaaatctcagtaggagtggtcccactcagttgaaacagttgtctggatccatttt
gtggatggcaccagaagtcacagaatgcaagataaaaatccatacagcttccagtcagatgtata
tgcatctgggatgtctgtatgaaatgatgactggacagttaccttatcaaacatcaacaaacag
ggaccagataattttatgggtgggacgaggatacctgtctccagatctcagtaaggtacgggataa
ctgtccaaaagccatgaagagattaatggcagagtgctccaaaagaaaagagatgagagaccact
ctttccccaaatctctcgcctctatagactgctggcccgcctcattgcccacaaatccaccagctgc
atcagaacctccttgaatcgggctgggttccaaacagaggatttttagtctataatgctgtgctc
tccaaaaacacctccaggcagggggtatgggtcgtttccctgtccactgaaaacaaatgagtgag
agagttcaggagagtgcaacaaaaggaaaataaatgaacatagtttgcttatatgttaaatga
ataaaatctctcttttttaaggtggaaaaaaaaaaaaaaaaaaaaaaaaaaaaaaaaaaaaa
aacc (SEQ ID NO:1)

Figure 1

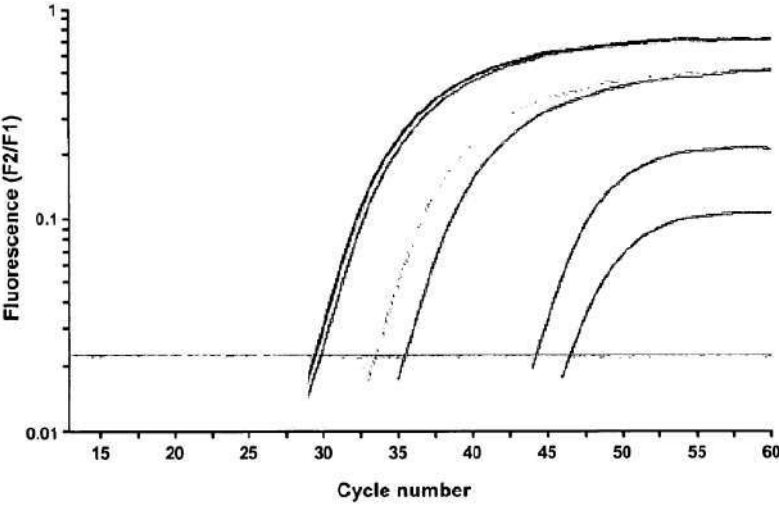

Figure 2

ABSTRACT

A SYSTEM FOR CANCER DETECTION AND MONITORING USING CUSTOMIZED DETECTION OF CIRCULATING DNA AND METHOD THEREOF

5 **[025]** The present invention discloses a system for cancer detection and
monitoring using customized detection of circulating DNA and method thereof. In
the present invention, a means for supplying the nucleic acid from a peripheral
blood sample taken from the subject; and contacting the nucleic acid with at least
a first primer under circumstances that will cause the amplification of the BRAF
10 gene or a fragment of it if the BRAF gene is present in the peripheral blood
sample; and a processing device for determining whether the BRAF gene or a
fragment of it contains a mutation in comparison to a wild-type BRAF sequence.
Further, obtaining a plasma sample from the BRAF gene and extracting the DNA
therefrom to create a target DNA sample; and adding to the target DNA sample,
15 wherein a combination of oligonucleotide primers suitable for PCR amplification
of a fragment of the human telomerase reverse transcriptase (BRAF) gene.

Accompanied Drawing **[FIGS. 1-2]**



Intellectual
Property
Office

Certificate of Registration for a UK Design

Design number: 6275723

Grant date: 27 April 2023

Registration date: 16 April 2023

This is to certify that,

in pursuance of and subject to the provision of Registered Designs Act 1949, the design of which a representation or specimen is attached, had been registered as of the date of registration shown above in the name of

Dr.Rudra Narayan Sahoo, Dr.Ashish Kumar Sarangi, Dr.Sovan Pattanaik,

Mr.Biswajit Sahoo

in respect of the application of such design to:

Insulin Pump

International Design Classification:

Version: 14-2023

Class: 24 MEDICAL AND LABORATORY EQUIPMENT

Subclass: 01 APPARATUS AND EQUIPMENT FOR DOCTORS, HOSPITALS
AND LABORATORIES

Adam Williams

Comptroller-General of Patents, Designs and Trade Marks

Intellectual Property Office

The attention of the Proprietor(s) is drawn to the important notes overleaf.



Representation of Designs

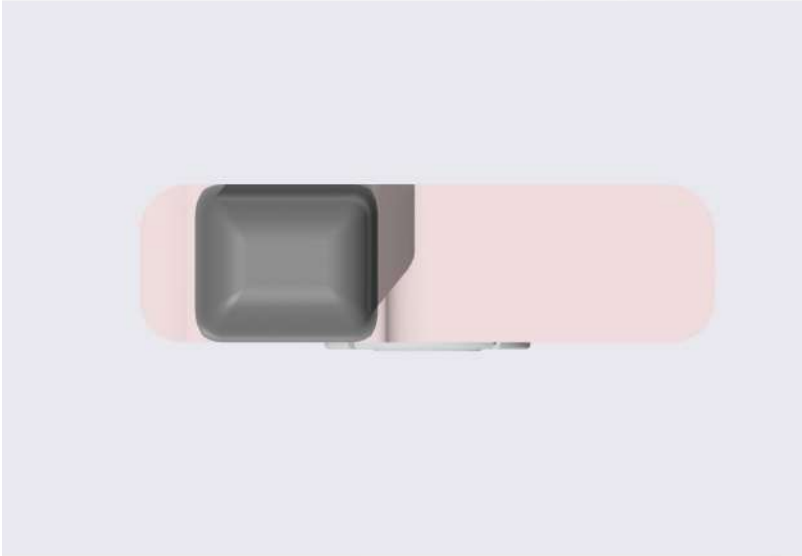

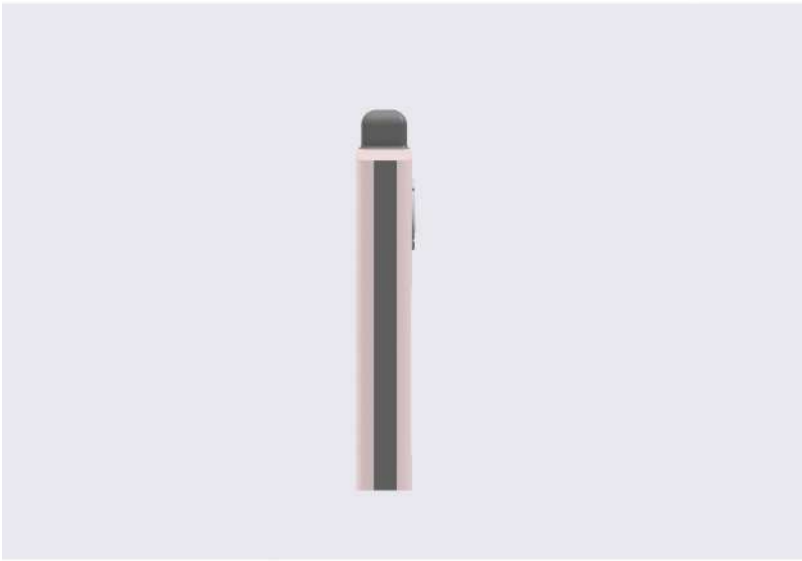
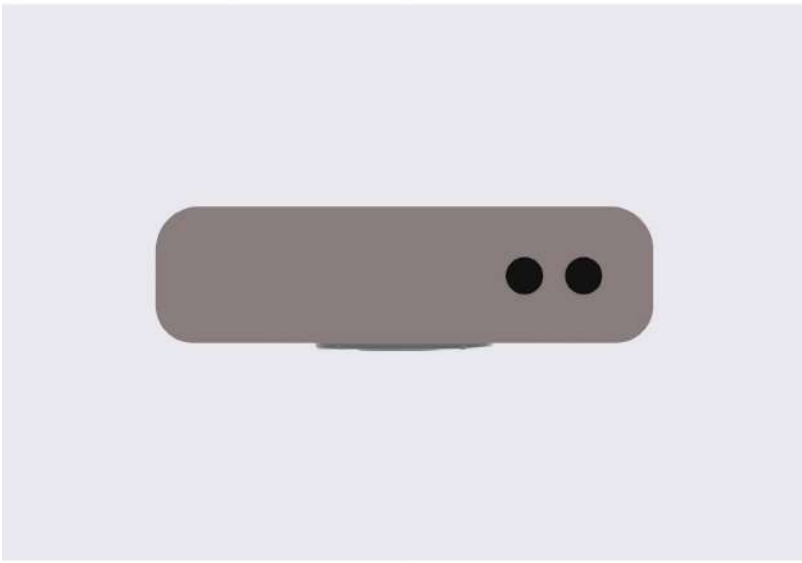

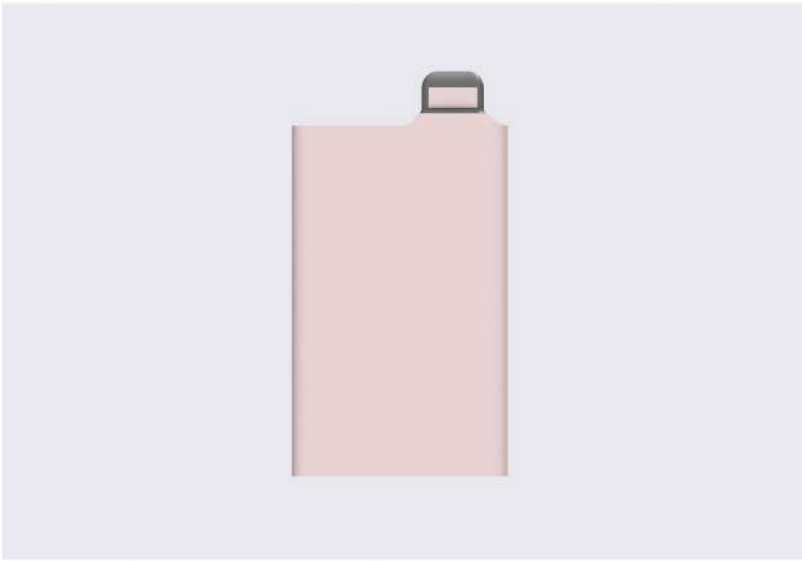



Intellectual Property Office is an operating name of the Patent Office

www.gov.uk/ipo



Intellectual
Property
Office

Certificate of Registration for a UK Design

Design number: 6328844

Grant date: 01 December 2023

Registration date: 25 November 2023

This is to certify that,

in pursuance of and subject to the provision of Registered Designs Act 1949, the design of which a representation or specimen is attached, had been registered as of the date of registration shown above in the name of

Dr . MALMARUGAN DEVANATHAN, Dr. JIWAN PREMCHAND LAVANDE, Dr .

MANOJ ANANDAKUMARI SANKARAN, Dr. SIVANAGIREDDY KALLI, Dr.

GOUTAM KUMAR MAHATO, Ms. MANO PRIYA VIJAYAN, Dr. SUBASHINI

SELVARAJ PREMKUMAR, Dr. KANNAN VELLINGIRI

in respect of the application of such design to:

MEDICAL DEVICE FOR MEASURING BODILY FLUID IN NEONATES

International Design Classification:

Version: 14-2023

Class: 24 MEDICAL AND LABORATORY EQUIPMENT

Subclass: 01 APPARATUS AND EQUIPMENT FOR DOCTORS, HOSPITALS
AND LABORATORIES

Adam Williams

Comptroller-General of Patents, Designs and Trade Marks
Intellectual Property Office

The attention of the Proprietor(s) is drawn to the important notes overleaf.



Representation of Designs

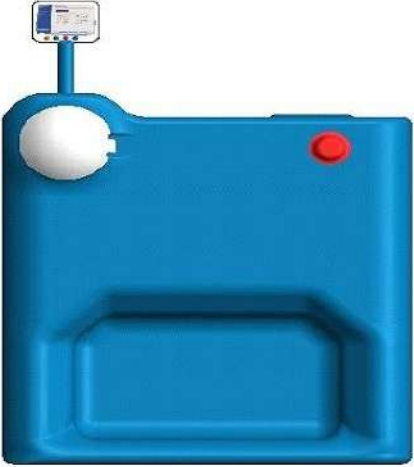

FRONT VIEW

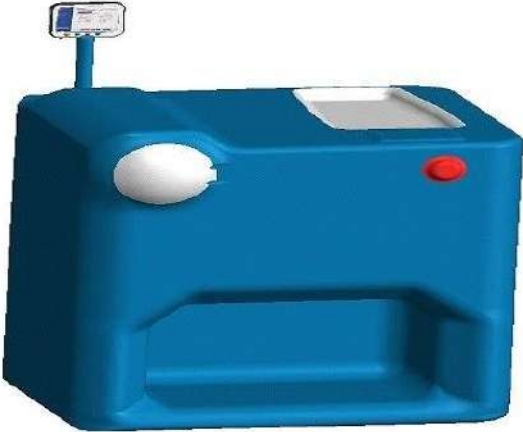

ISOMETRIC VIEW



LEFT SIDE VIEW



REAR VIEW



TOP VIEW

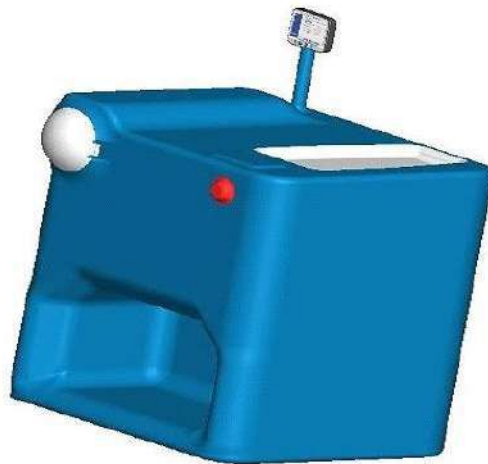

TRI METRIC VIEW



ORIGINAL

मूल/No : 130680



भारत सरकार
GOVERNMENT OF INDIA
पेटेंट कार्यालय
THE PATENT OFFICE

डिजाइन के पंजीकरण का प्रमाणपत्र
CERTIFICATE OF REGISTRATION OF DESIGN

डिजाइन सं. / Design No. : 375821-001
तारीख / Date : 19/12/2022
पारस्परिकता तारीख / Reciprocity Date* :
देश / Country :

प्रमाणित किया जाता है कि संलग्न प्रति में वर्णित डिजाइन जो **EMERGENCY VENTILATOR** से संबंधित है, का पंजीकरण, श्रेणी **24-01** में 1.Dr.Ashish Kumar Sarangi 2. Dr.Rudra Narayan Sahoo 3.Dr.Bhabani Sankar Satapathy 4.Dr.Kalpita Bhatta के नाम में उपर्युक्त संख्या और तारीख में कर लिया गया है।

Certified that the design of which a copy is annexed hereto has been registered as of the number and date given above in class **24-01** in respect of the application of such design to **EMERGENCY VENTILATOR** in the name of 1.Dr.Ashish Kumar Sarangi 2. Dr.Rudra Narayan Sahoo 3.Dr.Bhabani Sankar Satapathy 4.Dr.Kalpita Bhatta.

डिजाइन अधिनियम, 2000 तथा डिजाइन नियम, 2001 के अध्याधीन प्रावधानों के अनुसरण में।

In pursuance of and subject to the provisions of the Designs Act, 2000 and the Designs Rules, 2001.

INTELLECTUAL
PROPERTY INDIA
PATENTS | DESIGNS | TRADE MARKS
GEOGRAPHICAL INDICATIONS

निर्गमन की तारीख/Date of Issue : 13/03/2023

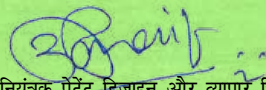
महानियंत्रक पेटेंट डिजाइन और व्यापार चिह्न
Controller General of Patents, Designs and Trade Marks

पारस्परिकता तारीख (यदि कोई हो) जिसकी अनुमति देश के नाम पर की गई है। डिजाइन का सत्त्वाधिकार पंजीकरण की तारीख से दस वर्षों के लिए होगा जिसका विस्तार, अधिनियम एवं नियम के निबंधनों के अधीन, पाँच वर्षों की अतिरिक्त अवधि के लिए किया जा सकेगा। इस प्रमाण पत्र का उपयोग विधिक कार्यवाहियों अथवा विदेश में पंजीकरण प्राप्त करने के लिए नहीं हो सकता है।

*The reciprocity date (if any) which has been allowed and the name of the country. Copyright in the design will subsist for ten years from the date of Registration, and may under the terms of the Act and Rules, be extended for a further period of five years. This Certificate is not for use in legal proceedings or for obtaining registration abroad.



ORIGINAL

मूल/No : 136294



भारत सरकार
GOVERNMENT OF INDIA
पेटेंट कार्यालय
THE PATENT OFFICE
डिजाइन के पंजीकरण का प्रमाणपत्र
CERTIFICATE OF REGISTRATION OF DESIGN

डिजाइन सं. / Design No. : 380262-001
तारीख / Date : 27/02/2023
पारस्परिकता तारीख / Reciprocity Date* :
देश / Country :

प्रमाणित किया जाता है कि संलग्न प्रति में वर्णित डिजाइन जो **DIGIHALER** से संबंधित है, का पंजीकरण, श्रेणी **24-02** में 1.Dr.Ashish Kumar Sarangi 2. Dr.Rudra Narayan Sahoo 3.Mr.Himansu Bhusan Samal 4.Dr.Kalpita Bhatta के नाम में उपर्युक्त संख्या और तारीख में कर लिया गया है।

Certified that the design of which a copy is annexed hereto has been registered as of the number and date given above in class **24-02** in respect of the application of such design to **DIGIHALER** in the name of 1.Dr.Ashish Kumar Sarangi 2. Dr.Rudra Narayan Sahoo 3.Mr.Himansu Bhusan Samal 4.Dr.Kalpita Bhatta.

डिजाइन अधिनियम, 2000 तथा डिजाइन नियम, 2001 के अध्याधीन प्रावधानों के अनुसरण में।

In pursuance of and subject to the provisions of the Designs Act, 2000 and the Designs Rules, 2001.

INTELLECTUAL
PROPERTY INDIA
PATENTS | DESIGNS | TRADE MARKS
GEOGRAPHICAL INDICATIONS

निर्गमन की तारीख/Date of Issue : 17/05/2023

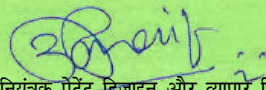
महानियंत्रक पेटेंट डिजाइन और व्यापार चिह्न
Controller General of Patents, Designs and Trade Marks

पारस्परिकता तारीख (यदि कोई हो) जिसकी अनुमति देश के नाम पर की गई है। डिजाइन का सत्त्वाधिकार पंजीकरण की तारीख से दस वर्षों के लिए होगा जिसका विस्तार, अधिनियम एवं नियम के निबंधनों के अधीन, पाँच वर्षों की अतिरिक्त अवधि के लिए किया जा सकेगा। इस प्रमाण पत्र का उपयोग विधिक कार्यवाहियों अथवा विदेश में पंजीकरण प्राप्त करने के लिए नहीं हो सकता है।

*The reciprocity date (if any) which has been allowed and the name of the country. Copyright in the design will subsist for ten years from the date of Registration, and may under the terms of the Act and Rules, be extended for a further period of five years. This Certificate is not for use in legal proceedings or for obtaining registration abroad.



ORIGINAL
क्रम सं/ Serial No. : 140509



पेटेंट कार्यालय, भारत सरकार

The Patent Office, Government Of India

डिजाइन के पंजीकरण का प्रमाण पत्र | Certificate of Registration of Design

डिजाइन सं. / Design No. : 383531-001

तारीख / Date : 10/04/2023

पारस्परिकता तारीख / Reciprocity Date* :
 *Reciprocity date is not applicable for designs registered on or after 10/04/2023.

देश / Country :

प्रमाणित किया जाता है कि संलग्न प्रति में वर्णित डिजाइन जो *BIOMETRIC DEVICE IN CAR* से संबंधित है, का पंजीकरण, श्रेणी 12-16 में 1.Dr. A. Vijayakumar 2. Dr. D. Uma 3.Dr. Upender Kumar 4.Dr. J.Ganesh Murali 5.Colonel Prof. Dr. N N. Murthy 6.Dr. Pramod Kumar Patjoshi 7.Dr. Biru Rajak 8.Dr. Mohammed Siddique 9.Dr. V.Kannan के नाम में उपर्युक्त संख्या और तारीख में कर लिया गया है।

Certified that the design of which a copy is annexed hereto has been registered as of the number and date given above in class 12-16 in respect of the application of such design to *BIOMETRIC DEVICE IN CAR* in the name of 1.Dr. A. Vijayakumar 2. Dr. D. Uma 3.Dr. Upender Kumar 4.Dr. J.Ganesh Murali 5.Colonel Prof. Dr. N N. Murthy 6.Dr. Pramod Kumar Patjoshi 7.Dr. Biru Rajak 8.Dr. Mohammed Siddique 9.Dr. V.Kannan.

डिजाइन अधिनियम, 2000 तथा डिजाइन नियम, 2001 के अध्याधीन प्रावधानों के अनुसरण में।

In pursuance of and subject to the provisions of the Designs Act, 2000 and the Designs Rules, 2001.

जारी करने की तिथि : 13/07/2023
Date of Issue



महानियंत्रक पेटेंट, डिजाइन और व्यापार चिह्न
Controller General of Patents, Designs and Trade Marks

*पारस्परिकता तारीख (यदि कोई हो) जिसकी अनुमति दी गई है तथा देश का नाम। डिजाइन का स्वत्वाधिकार पंजीकरण की तारीख से दस वर्षों के लिए होगा जिसका विस्तार, अधिनियम एवं नियम के निबंधनों के अधीन, पाँच वर्षों की अतिरिक्त अवधि के लिए किया जा सकेगा। इस प्रमाण पत्र का उपयोग विधिक कार्यवाहियों अथवा विदेश में पंजीकरण प्राप्त करने के लिए नहीं हो सकता है।

The reciprocity date (if any) which has been allowed and the name of the country. Copyright in the design will subsist for ten years from the date of Registration, and may under the terms of the Act and Rules, be extended for a further period of five years. This Certificate is not for use in legal proceedings or for obtaining registration abroad.



Controller General of Patents, Designs and Trademarks
Department of Industrial Policy and Promotion
Ministry of Commerce and Industry

Design Application Details

Application Number: 374952-001

Cbr Number: 209220

Cbr Date: 02/12/2022 10:40:00

Applicant Name:

1. Centurion University of Technology and Management (CUTM)
2. Prof. Nimay Chandra Giri
3. Dr. Ramesh Chandra Mohanty

Design Application Status

Application Status: Examination Report has been Generated ,Online Reply Document Recived(FER generated on 17/01/2023)

[Back](#)

Design Application Details

Application Number:	374953-001
Cbr Number:	209220
Cbr Date:	02/12/2022 10:40:00
Applicant Name:	<ol style="list-style-type: none">1. Centurion University of Technology and Management (CUTM)2. Prof. Nimay Chandra Giri3. Suraj Kumar4. Dr. Dehani Prasad Mishra5. Dr. Namrata Sengar

Design Application Status

Application Status:	Examination Report has been Generated ,Online Reply Document Recived(FER generated on 07/02/2023)
----------------------------	---

[Back](#)

ORIGINAL
क्रम सं/ Serial No. : 140510



पेटेंट कार्यालय, भारत सरकार | The Patent Office, Government Of India

डिजाइन के पंजीकरण का प्रमाण पत्र | Certificate of Registration of Design

डिजाइन सं. / Design No. : 383997-001

तारीख / Date : 15/04/2023

पारस्परिकता तारीख / Reciprocity Date* :

देश / Country :

प्रमाणित किया जाता है कि संलग्न प्रति में वर्णित डिजाइन जो **IOT BASED SOLAR POWERED AGRICULTURE ROBOT** से संबंधित है, का पंजीकरण, श्रेणी 15-03 में 1.Ms.Sima Das 2. Dr.Tanmay Kumar Behera 3.Prof.Monojit Manna 4.Prof.Mohammad Ashique Azad 5.Prof. Subrata Modak, 6.Prof. Lab Kumar Mudi 7.Dr.Soumya Ranjan Das 8.Prof.Rabindranath Sahu 9.Dr.Nimay Chandra Giri के नाम में उपर्युक्त संख्या और तारीख में कर लिया गया है।

Certified that the design of which a copy is annexed hereto has been registered as of the number and date given above in class 15-03 in respect of the application of such design to **IOT BASED SOLAR POWERED AGRICULTURE ROBOT** in the name of 1.Ms.Sima Das 2. Dr.Tanmay Kumar Behera 3.Prof.Monojit Manna 4.Prof.Mohammad Ashique Azad 5.Prof. Subrata Modak, 6.Prof. Lab Kumar Mudi 7.Dr.Soumya Ranjan Das 8.Prof.Rabindranath Sahu 9.Dr.Nimay Chandra Giri.

डिजाइन अधिनियम, 2000 तथा डिजाइन नियम, 2001 के अधधीन प्रावधानों के अनुसरण में।

In pursuance of and subject to the provisions of the Designs Act, 2000 and the Designs Rules, 2001.



महानियंत्रक पेटेंट, डिजाइन और व्यापार चिह्न
Controller General of Patents, Designs and Trade Marks

जारी करने की तिथि : 13/07/2023
Date of Issue

*पारस्परिकता तारीख (यदि कोई हो) जिसकी अनुमति दी गई है तथा देश का नाम। डिजाइन का स्वत्वाधिकार पंजीकरण की तारीख से दस वर्षों के लिए होगा जिसका विस्तार, अधिनियम एवं नियम के निबंधनों के अधीन, पाँच वर्षों की अतिरिक्त अवधि के लिए किया जा सकेगा। इस प्रमाण पत्र का उपयोग विधिक कार्यवाहियों अथवा विदेश में पंजीकरण प्राप्त करने के लिए नहीं हो सकता है।
The reciprocity date (if any) which has been allowed and the name of the country. Copyright in the design will subsist for ten years from the date of Registration, and may under the terms of the Act and Rules, be extended for a further period of five years. This Certificate is not for use in legal proceedings or for obtaining registration abroad.



Intellectual
Property
Office

Certificate of Registration for a UK Design

Design number: 6305305

Grant date: 04 September 2023

Registration date: 24 August 2023

This is to certify that,

in pursuance of and subject to the provision of Registered Designs Act 1949, the design of which a representation or specimen is attached, had been registered as of the date of registration shown above in the name of

Ms. Meenakshi Attri, Dr. Neetu Sharma, Ms. Swati Mehta, Dr. Nida Abdulrashid

Patel, Ms. Supneet Kour, Ms. Bhumika Kapoor, Shesh Narayan Kumawat, Prof.

Nimay Chandra Giri

in respect of the application of such design to:

AGRICULTURAL DRONE FOR CROP HEALTH MONITORING

International Design Classification:

Version: 14-2023

Class: 12 MEANS OF TRANSPORT OR HOISTING

Subclass: 07 AIRCRAFT AND SPACE VEHICLES

Adam Williams

Comptroller-General of Patents, Designs and Trade Marks

Intellectual Property Office

The attention of the Proprietor(s) is drawn to the important notes overleaf.



Representation of Designs

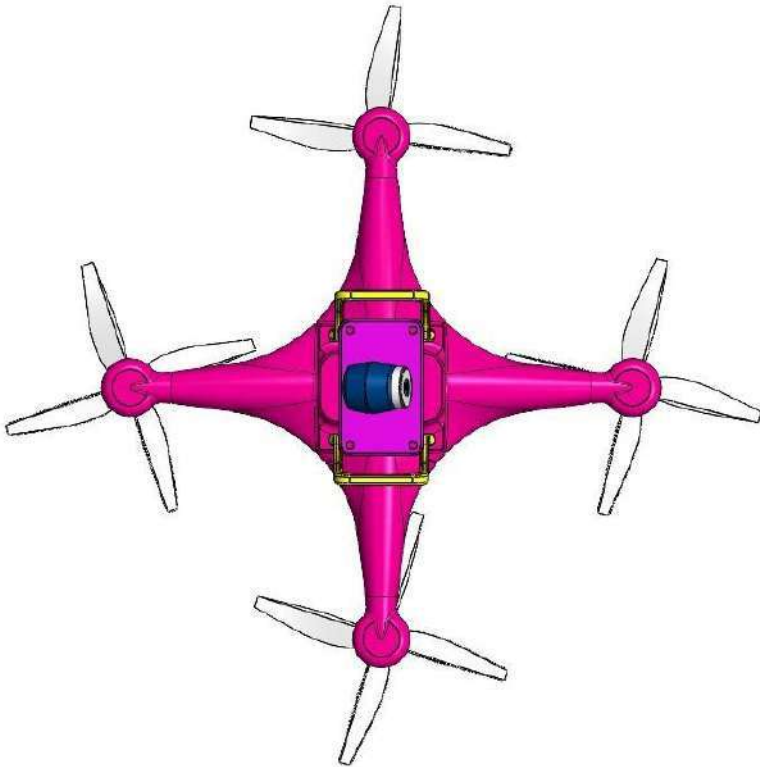

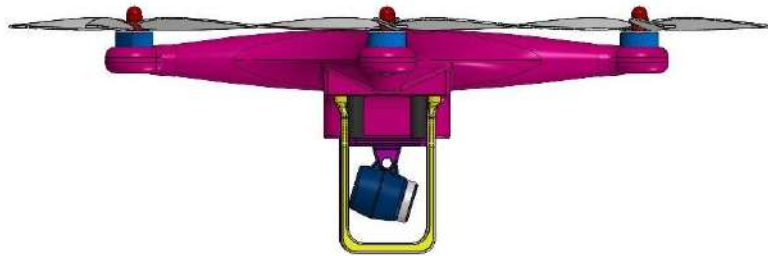



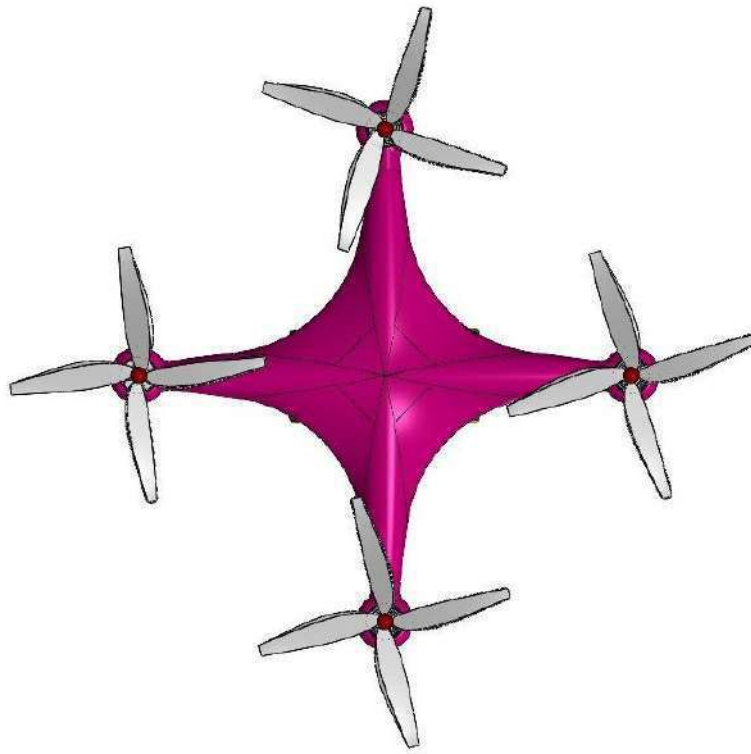

Intellectual Property Office is an operating name of the Patent Office

www.gov.uk/ipo



Intellectual
Property
Office

Certificate of Registration for a UK Design

Design number: 6305801

Grant date: 07 September 2023

Registration date: 25 August 2023

This is to certify that,

in pursuance of and subject to the provision of Registered Designs Act 1949, the design of which a representation or specimen is attached, had been registered as of the date of registration shown above in the name of

Dr. Sivarami Reddy Narapureddy, Prof. Nimay Chandra Giri, Dr. Padma Lalitha

Mareddy, Dr. Hemakesavulu Oruganti, Dr. Gopi Pasala, Dr. Suneetha Irala, Mr.

Sreeramula Reddy Nandyala, Dr. Cristina Efremov

in respect of the application of such design to:

AGRICULTURE DRONE FOR MONITORING AND SPRAYING PESTICIDES

International Design Classification:

Version: 14-2023

Class: 12 MEANS OF TRANSPORT OR HOISTING

Subclass: 07 AIRCRAFT AND SPACE VEHICLES

Adam Williams

Comptroller-General of Patents, Designs and Trade Marks

Intellectual Property Office

The attention of the Proprietor(s) is drawn to the important notes overleaf.



Representation of Designs

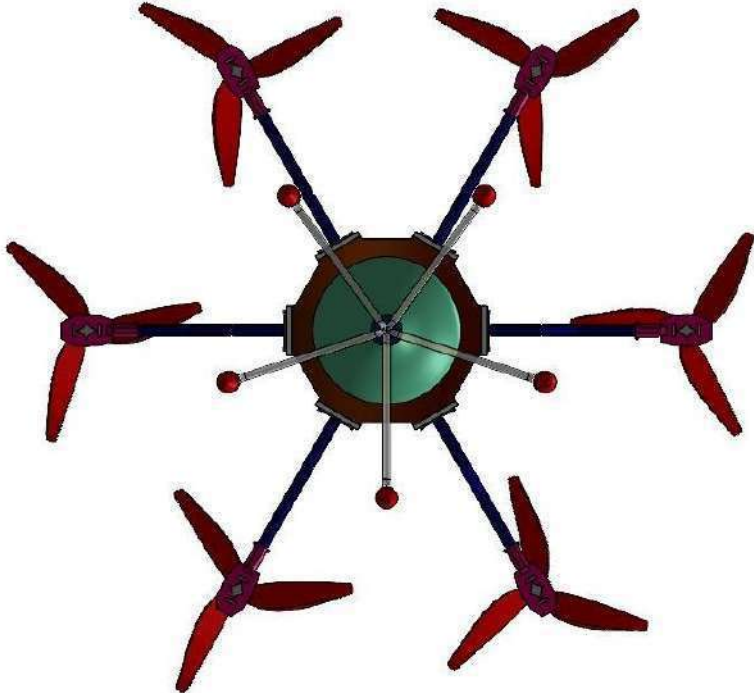
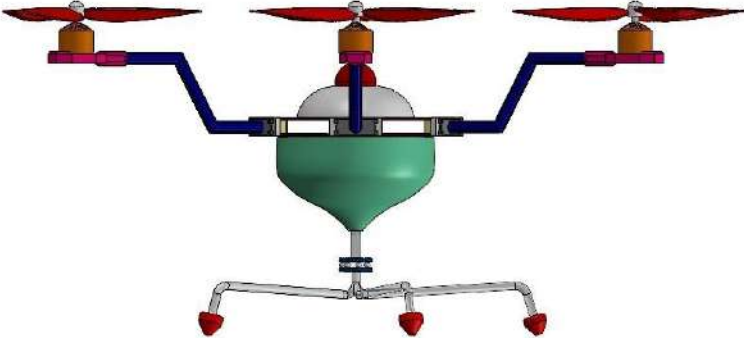

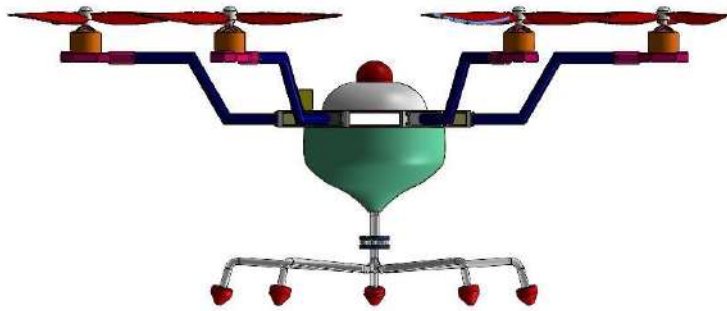
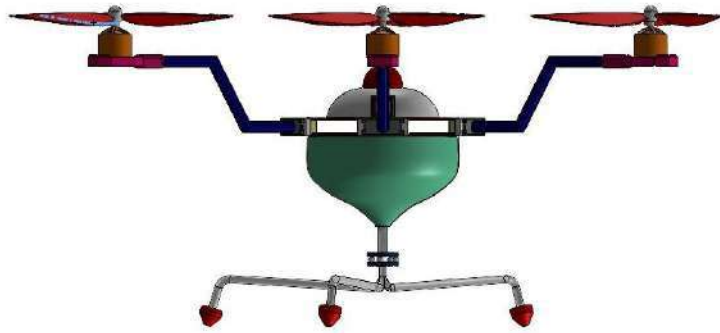



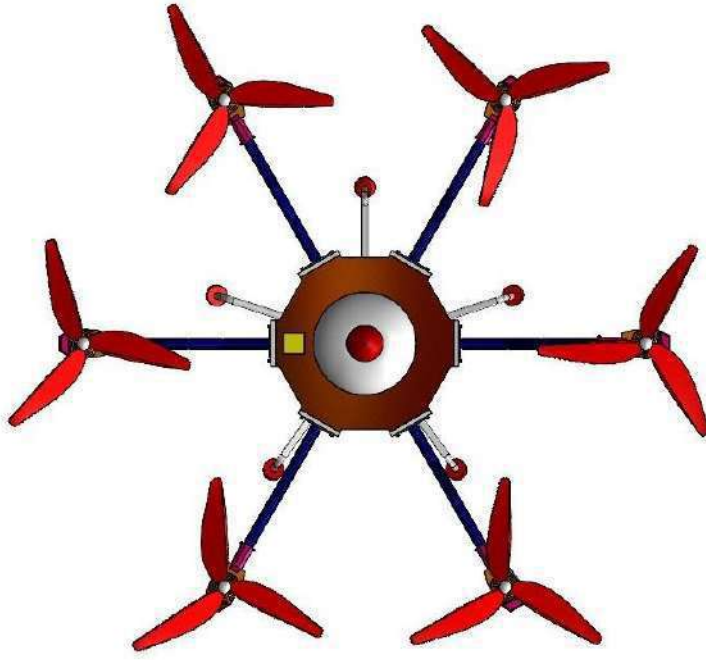

Intellectual Property Office is an operating name of the Patent Office

www.gov.uk/ipo



ORIGINAL
क्रम सं/ Serial No. : 145622



पेटेंट कार्यालय, भारत सरकार | The Patent Office, Government Of India

डिजाइन के पंजीकरण का प्रमाण पत्र | Certificate of Registration of Design

डिजाइन सं. / Design No. : 394136-001

तारीख / Date : 31/08/2023

पारस्परिकता तारीख / Reciprocity Date* :

देश / Country :

प्रमाणित किया जाता है कि संलग्न प्रति में वर्णित डिजाइन जो **HOT AIR ASSISTED INFRARED HYBRID DRYER** से संबंधित है, का पंजीकरण, श्रेणी 15-05 में 1.Dr. Gitanjali Behera 2. Dr. Bhukya Jithender 3.Ms. Shreedatta Satapathy 4.Ms. Swatalinatripathy 5.Ms. Soumya Sucharita Giri 6.Ms. Mimansa Dasmal 7.Mr. Debjit Maity 8.Mr. Ranit Sarkar 9.Prof. Nimay Chandra Giri के नाम में उपर्युक्त संख्या और तारीख में कर लिया गया है।

Certified that the design of which a copy is annexed hereto has been registered as of the number and date given above in class 15-05 in respect of the application of such design to **HOT AIR ASSISTED INFRARED HYBRID DRYER** in the name of 1.Dr. Gitanjali Behera 2. Dr. Bhukya Jithender 3.Ms. Shreedatta Satapathy 4.Ms. Swatalinatripathy 5.Ms. Soumya Sucharita Giri 6.Ms. Mimansa Dasmal 7.Mr. Debjit Maity 8.Mr. Ranit Sarkar 9.Prof. Nimay Chandra Giri.

डिजाइन अधिनियम, 2000 तथा डिजाइन नियम, 2001 के अधधीन प्रावधानों के अनुसरण में।

In pursuance of and subject to the provisions of the Designs Act, 2000 and the Designs Rules, 2001.

जारी करने की तिथि : 12/10/2023
Date of Issue



[Signature]

महानियंत्रक पेटेंट, डिजाइन और व्यापार चिह्न
Controller General of Patents, Designs and Trade Marks

*पारस्परिकता तारीख (यदि कोई हो) जिसकी अनुमति दी गई है तथा देश का नाम। डिजाइन का स्वत्वाधिकार पंजीकरण की तारीख से दस वर्षों के लिए होगा जिसका विस्तार, अधिनियम एवं नियम के निबंधनों के अधीन, पाँच वर्षों की अतिरिक्त अवधि के लिए किया जा सकेगा। इस प्रमाण पत्र का उपयोग विधिक कार्यवाहियों अथवा विदेश में पंजीकरण प्राप्त करने के लिए नहीं हो सकता है।

The reciprocity date (if any) which has been allowed and the name of the country. Copyright in the design will subsist for ten years from the date of Registration, and may under the terms of the Act and Rules, be extended for a further period of five years. This Certificate is not for use in legal proceedings or for obtaining registration abroad.



ORIGINAL
क्रम सं/ Serial No. : 149718



पेटेंट कार्यालय, भारत सरकार | The Patent Office, Government Of India

डिजाइन के पंजीकरण का प्रमाण पत्र | Certificate of Registration of Design

डिजाइन सं. / Design No. : 381143-001

तारीख / Date : 09/03/2023

पारस्परिकता तारीख / Reciprocity Date* : -

देश / Country : -

प्रमाणित किया जाता है कि संलग्न प्रति में वर्णित डिजाइन जो **WEARABLE TEXTILE ANTENNA FOR TELEMEDICINE APPLICATION** से संबंधित है, का पंजीकरण, श्रेणी 14-03 में 1.Dr. Sasmita Pahadsingh 2. Dr. Upali Aparajita Dash 3.Dr. Tejaswini Kar 4.Dr. Sraddhanjali Mohapatra 5.Dr. Lizina Khatua 6.Prof. Wishard La Vincent Barreto 7.Prof. Manisha Panda 8.Prof. Sangram Kishore Routray 9.Dr. Nimay Chandra Giri के नाम में उपर्युक्त संख्या और तारीख में कर लिया गया है।

Certified that the design of which a copy is annexed herewith has been registered as of the number and date given above in class 14-03 in respect of the application of such design to **WEARABLE TEXTILE ANTENNA FOR TELEMEDICINE APPLICATION** in the name of 1.Dr. Sasmita Pahadsingh 2. Dr. Upali Aparajita Dash 3.Dr. Tejaswini Kar 4.Dr. Sraddhanjali Mohapatra 5.Dr. Lizina Khatua 6.Prof. Wishard La Vincent Barreto 7.Prof. Manisha Panda 8.Prof. Sangram Kishore Routray 9.Dr. Nimay Chandra Giri.

डिजाइन अधिनियम, 2000 तथा डिजाइन नियम, 2001 के अधधीन प्रावधानों के अनुसरण में।

In pursuance of and subject to the provisions of the Designs Act, 2000 and the Designs Rules, 2001.



(Signature)

महानियंत्रक पेटेंट, डिजाइन और व्यापार चिह्न
Controller General of Patents, Designs and Trade Marks

जारी करने की तिथि : 08/12/2023
Date of Issue

*पारस्परिकता तारीख (यदि कोई हो) जिसकी अनुमति दी गई है तथा देश का नाम। डिजाइन का स्वत्वाधिकार पंजीकरण की तारीख से दस वर्षों के लिए होगा जिसका विस्तार, अधिनियम एवं नियम के निबंधनों के अधीन, पाँच वर्षों की अतिरिक्त अवधि के लिए किया जा सकेगा। इस प्रमाण पत्र का उपयोग विधिक कार्यवाहियों अथवा विदेश में पंजीकरण प्राप्त करने के लिए नहीं हो सकता है।

The reciprocity date (if any) which has been allowed and the name of the country. Copyright in the design will subsist for ten years from the date of Registration, and may under the terms of the Act and Rules, be extended for a further period of five years. This Certificate is not for use in legal proceedings or for obtaining registration abroad.



ORIGINAL
क्रम सं/ Serial No. : 141282



पेटेंट कार्यालय, भारत सरकार | The Patent Office, Government Of India

डिजाइन के पंजीकरण का प्रमाण पत्र | Certificate of Registration of Design

डिजाइन सं. / Design No. : 387327-001

तारीख / Date : 31/05/2023

पारस्परिकता तारीख / Reciprocity Date* :

देश / Country :

प्रमाणित किया जाता है कि संलग्न प्रति में वर्णित डिजाइन जो **SOLAR PANEL FOR AGRICULTURE ACTIVITIES** से संबंधित है, का पंजीकरण, श्रेणी 13-04 में 1.Ms.Meenakshi Attri 2. Dr.Rubby Sandhu 3.Dr. Sandeep Kumar Bangarwa 4.Dr. Ravindra Kumar 5.Dr. Ashish Sheera 6.Ms.Qurat-Ul-Ain-Aga 7.Ms.Renuka 8.Mr.Hritik Srivastava 9.Dr.Nimay Chandra Giri के नाम में उपर्युक्त संख्या और तारीख में कर लिया गया है।

Certified that the design of which a copy is annexed hereto has been registered as of the number and date given above in class 13-04 in respect of the application of such design to **SOLAR PANEL FOR AGRICULTURE ACTIVITIES** in the name of 1.Ms.Meenakshi Attri 2. Dr.Rubby Sandhu 3.Dr. Sandeep Kumar Bangarwa 4.Dr. Ravindra Kumar 5.Dr. Ashish Sheera 6.Ms.Qurat-Ul-Ain-Aga 7.Ms.Renuka 8.Mr.Hritik Srivastava 9.Dr.Nimay Chandra Giri.

डिजाइन अधिनियम, 2000 तथा डिजाइन नियम, 2001 के अध्याधीन प्रावधानों के अनुसरण में।

In pursuance of and subject to the provisions of the Designs Act, 2000 and the Designs Rules, 2001.

जारी करने की तिथि : 26/07/2023
Date of Issue



महानियंत्रक पेटेंट, डिजाइन और व्यापार चिह्न
Controller General of Patents, Designs and Trade Marks

*पारस्परिकता तारीख (यदि कोई हो) जिसकी अनुमति दी गई है तथा देश का नाम। डिजाइन का स्वत्वाधिकार पंजीकरण की तारीख से दस वर्षों के लिए होगा जिसका विस्तार, अधिनियम एवं नियम के निबंधनों के अधीन, पाँच वर्षों की अतिरिक्त अवधि के लिए किया जा सकेगा। इस प्रमाण पत्र का उपयोग विधिक कार्यवाहियों अथवा विदेश में पंजीकरण प्राप्त करने के लिए नहीं हो सकता है।
The reciprocity date (if any) which has been allowed and the name of the country. Copyright in the design will subsist for ten years from the date of Registration, and may under the terms of the Act and Rules, be extended for a further period of five years. This Certificate is not for use in legal proceedings or for obtaining registration abroad.



ORIGINAL
क्रम सं/ Serial No. : 149915



पेटेंट कार्यालय, भारत सरकार | The Patent Office, Government Of India

डिजाइन के पंजीकरण का प्रमाण पत्र | Certificate of Registration of Design

डिजाइन सं. / Design No. : 396462-001

तारीख / Date : 03/10/2023

पारस्परिकता तारीख / Reciprocity Date* :

देश / Country :

प्रमाणित किया जाता है कि संलग्न प्रति में वर्णित डिजाइन जो **AGRICULTURAL FERTILIZER SPREADER MACHINE** से संबंधित है, का पंजीकरण, श्रेणी 15-03 में 1.Ms. Swati Mehta 2. Ms. Supneet Kaur 3.Ms. Meenakshi Attri 4.Dr. Deepak Kumar 5.Dr.Ranjeet Singh Bochalya 6.Mr. Arjun Singh 7.Mr. Bhim Singh 8.Prof. Nimay Chandra Giri के नाम में उपर्युक्त संख्या और तारीख में कर लिया गया है।

Certified that the design of which a copy is annexed hereto has been registered as of the number and date given above in class 15-03 in respect of the application of such design to **AGRICULTURAL FERTILIZER SPREADER MACHINE** in the name of 1.Ms. Swati Mehta 2. Ms. Supneet Kaur 3.Ms. Meenakshi Attri 4.Dr. Deepak Kumar 5.Dr.Ranjeet Singh Bochalya 6.Mr. Arjun Singh 7.Mr. Bhim Singh 8.Prof. Nimay Chandra Giri.

डिजाइन अधिनियम, 2000 तथा डिजाइन नियम, 2001 के अध्यक्षीन प्रावधानों के अनुसरण में।

In pursuance of and subject to the provisions of the Designs Act, 2000 and the Designs Rules, 2001.

जारी करने की तिथि : 08/12/2023
Date of Issue



(Signature)

महानियंत्रक पेटेंट, डिजाइन और व्यापार चिह्न
Controller General of Patents, Designs and Trade Marks

*पारस्परिकता तारीख (यदि कोई हो) जिसकी अनुमति दी गई है तथा देश का नाम। डिजाइन का स्वत्वाधिकार पंजीकरण की तारीख से दस वर्षों के लिए होगा जिसका विस्तार, अधिनियम एवं नियम के निबंधनों के अधीन, पाँच वर्षों की अतिरिक्त अवधि के लिए किया जा सकेगा। इस प्रमाण पत्र का उपयोग विधिक कार्यवाहियों अथवा विदेश में पंजीकरण प्राप्त करने के लिए नहीं हो सकता है।
The reciprocity date (if any) which has been allowed and the name of the country. Copyright in the design will subsist for ten years from the date of Registration, and may under the terms of the Act and Rules, be extended for a further period of five years. This Certificate is not for use in legal proceedings or for obtaining registration abroad.



Intellectual
Property
Office

Certificate of Registration for a UK Design

Design number: 6317640

Grant date: 12 October 2023

Registration date: 07 October 2023

This is to certify that,

in pursuance of and subject to the provision of Registered Designs Act 1949, the design of which a representation or specimen is attached, had been registered as of the date of registration shown above in the name of

Dr. Satyasis Mishra, Dr. Pradip Kumar Prusty, Mr. Deajeet Pramanik, Dr.

Subhashree Mohapatra, Dr. Srikanta Mohapatra, Mr. Debanksh Guha, Mr.

Akshat Jain, Mr. Arnab Kar, Mr. Bishnu Prasad Sahu

in respect of the application of such design to:

ARTIFICIAL INTELLIGENCE BASED NERVE ACTIVATION DEVICE FOR

HEALTHCARE TREATMENT

International Design Classification:

Version: 14-2023

Class: 24 MEDICAL AND LABORATORY EQUIPMENT

Subclass: 01 APPARATUS AND EQUIPMENT FOR DOCTORS, HOSPITALS
AND LABORATORIES

Adam Williams

Comptroller-General of Patents, Designs and Trade Marks
Intellectual Property Office

The attention of the Proprietor(s) is drawn to the important notes overleaf.



Representation of Designs

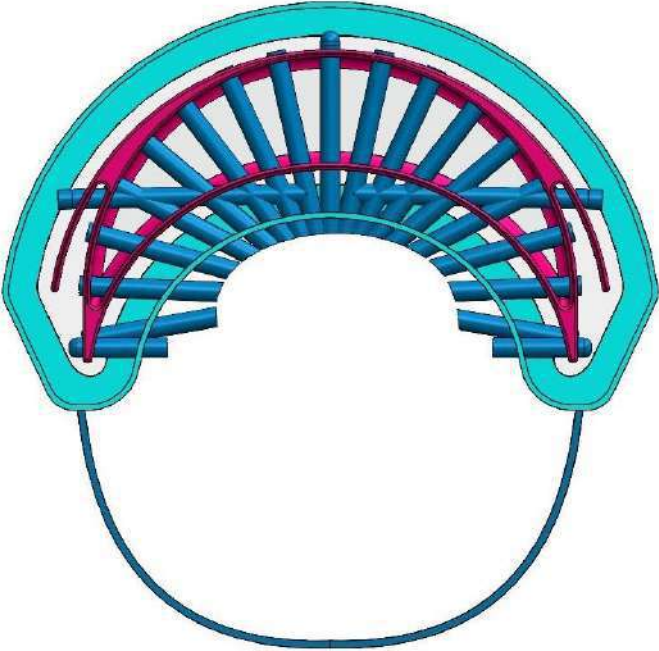

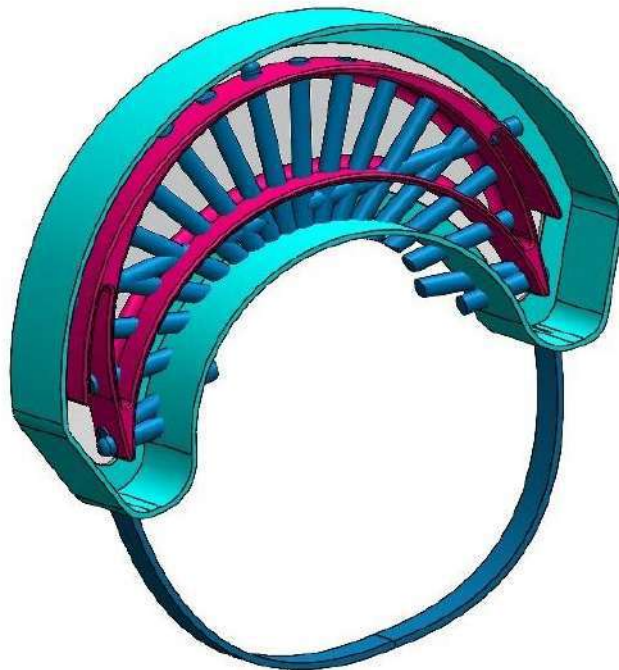
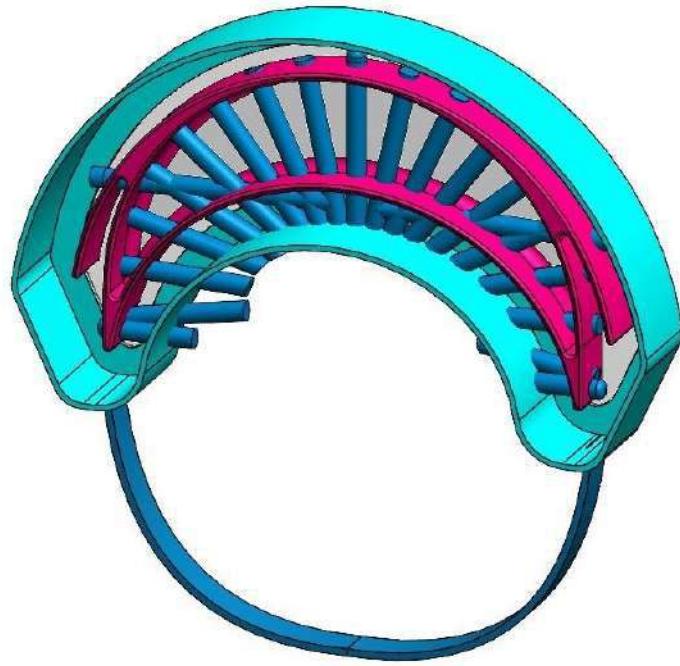

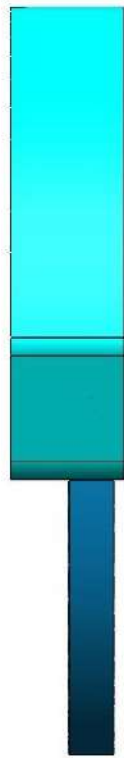



Intellectual Property Office is an operating name of the Patent Office

www.gov.uk/ipo



ORIGINAL
क्रम सं/ Serial No. : 145190



पेटेंट कार्यालय, भारत सरकार | The Patent Office, Government Of India

डिजाइन के पंजीकरण का प्रमाण पत्र | Certificate of Registration of Design

डिजाइन सं. / Design No. : 392036-001

तारीख / Date : 06/08/2023

पारस्परिकता तारीख / Reciprocity Date* : -

देश / Country : -

प्रमाणित किया जाता है कि संलग्न प्रति में वर्णित डिजाइन जो **ARTIFICIAL INTELLIGENCE DIETICIAN** से संबंधित है, का पंजीकरण, श्रेणी 24-02 में 1.Dr. Jobin Varghese 2. Dr P Sampath 3.Dr . Manoj As 4.Dr. Shahanawaj Ahamad 5.Dr. Sasmita Kumari Nayak 6.Dr. N.V.S.Natteshan 7.Mr. R.A. Manoj Kumar 8.Dr. V.Kannan के नाम में उपर्युक्त संख्या और तारीख में कर लिया गया है।

Certified that the design of which a copy is annexed hereto has been registered as of the number and date given above in class 24-02 in respect of the application of such design to **ARTIFICIAL INTELLIGENCE DIETICIAN** in the name of 1.Dr. Jobin Varghese 2. Dr P Sampath 3.Dr . Manoj As 4.Dr. Shahanawaj Ahamad 5.Dr. Sasmita Kumari Nayak 6.Dr. N.V.S.Natteshan 7.Mr. R.A. Manoj Kumar 8.Dr. V.Kannan.

डिजाइन अधिनियम, 2000 तथा डिजाइन नियम, 2001 के अध्याधीन प्रावधानों के अनुसरण में।

In pursuance of and subject to the provisions of the Designs Act, 2000 and the Designs Rules, 2001.



(Signature)
महानियंत्रक पेटेंट, डिजाइन और व्यापार चिह्न
Controller General of Patents, Designs and Trade Marks

जारी करने की तिथि : 05/10/2023
Date of Issue

*पारस्परिकता तारीख (यदि कोई हो) जिसकी अनुमति दी गई है तथा देश का नाम। डिजाइन का स्वत्वाधिकार पंजीकरण की तारीख से दस वर्षों के लिए होगा जिसका विस्तार, अधिनियम एवं नियम के निबंधनों के अधीन, पाँच वर्षों की अतिरिक्त अवधि के लिए किया जा सकेगा। इस प्रमाण पत्र का उपयोग विधिक कार्यवाहियों अथवा विदेश में पंजीकरण प्राप्त करने के लिए नहीं हो सकता है।
The reciprocity date (if any) which has been allowed and the name of the country. Copyright in the design will subsist for ten years from the date of Registration, and may under the terms of the Act and Rules, be extended for a further period of five years. This Certificate is not for use in legal proceedings or for obtaining registration abroad.



ORIGINAL
क्रम सं/ Serial No. : 149820



पेटेंट कार्यालय, भारत सरकार

The Patent Office, Government Of India

डिजाइन के पंजीकरण का प्रमाण पत्र | Certificate of Registration of Design

डिजाइन सं. / Design No. : 398816-001

तारीख / Date : 30/10/2023

पारस्परिकता तारीख / Reciprocity Date* :

देश / Country :

प्रमाणित किया जाता है कि संलग्न प्रति में वर्णित डिजाइन जो **PLANT ENERGY HARVESTING DEVICE** से संबंधित है, का पंजीकरण, श्रेणी 13-01 में 1.Dr. Swapnil 2. Dr. Digvijay Singh 3.Dr. Vangapandu Thriveni 4.Dr. Jagadeesha Mulagund 5.Dr. J. Surendar 6.Ms. Kowsalya K B 7.Er. Pramod Kumar 8.Prof. S. Eswara Reddy के नाम में उपर्युक्त संख्या और तारीख में कर लिया गया है।

Certified that the design of which a copy is annexed hereto has been registered as of the number and date given above in class 13-01 in respect of the application of such design to **PLANT ENERGY HARVESTING DEVICE** in the name of 1.Dr. Swapnil 2. Dr. Digvijay Singh 3.Dr. Vangapandu Thriveni 4.Dr. Jagadeesha Mulagund 5.Dr. J. Surendar 6.Ms. Kowsalya K B 7.Er. Pramod Kumar 8.Prof. S. Eswara Reddy.

डिजाइन अधिनियम, 2000 तथा डिजाइन नियम, 2001 के अध्याधीन प्रावधानों के अनुसरण में।

In pursuance of and subject to the provisions of the Designs Act, 2000 and the Designs Rules, 2001.

जारी करने की तिथि : 08/12/2023
Date of Issue :



(Signature)

महानियंत्रक, पेटेंट, डिजाइन और व्यापार चिह्न
Controller General of Patents, Designs and Trade Marks

*पारस्परिकता तारीख (यदि कोई हो) जिसकी अनुमति दी गई है तथा देश का नाम। डिजाइन का स्वत्वाधिकार पंजीकरण की तारीख से दस वर्षों के लिए होगा जिसका विस्तार अधिनियम एवं नियम के निबंधनों के अधीन, पाँच वर्षों की अतिरिक्त अवधि के लिए किया जा सकेगा। इस प्रमाण पत्र का उपयोग विधिक कार्यवाहियों अथवा विदेश में पंजीकरण प्राप्त करने के लिए नहीं हो सकता है।

The reciprocity date (if any) which has been allowed and the name of the country. Copyright in the design will subsist for ten years from the date of Registration, and may under the terms of the Act and Rules, be extended for a further period of five years. This Certificate is not for use in legal proceedings or for obtaining registration abroad.



ORIGINAL
क्रम सं/ Serial No. : 150268



पेटेंट कार्यालय, भारत सरकार | The Patent Office, Government Of India

डिजाइन के पंजीकरण का प्रमाण पत्र | Certificate of Registration of Design

डिजाइन सं. / Design No. : 397641-001

तारीख / Date : 14/10/2023

पारस्परिकता तारीख / Reciprocity Date* :

देश / Country :

प्रमाणित किया जाता है कि संलग्न प्रति में वर्णित डिजाइन जो **PESTICIDE DETECTION KNIFE FOR FRUITS** से संबंधित है, का पंजीकरण, श्रेणी 10-05 में 1.Dr. Vangapandu Thriveni 2. Dr. Swapnil 3.Dr. Digvijay Singh 4.Dr. Koustava Kumar Panda 5.Dr. S.P. Nanda 6.Dr. Ravi Kumar Kuna 7.Dr. Karthik Parmanik 8.Prof. M Subba Rao 9.Pamukuntla Mahesh 10.Prof. S. Eswara Reddy के नाम में उपर्युक्त संख्या और तारीख में कर लिया गया है।

Certified that the design of which a copy is annexed hereto has been registered as of the number and date given above in class 10-05 in respect of the application of such design to **PESTICIDE DETECTION KNIFE FOR FRUITS** in the name of 1.Dr. Vangapandu Thriveni 2. Dr. Swapnil 3.Dr. Digvijay Singh 4.Dr. Koustava Kumar Panda 5.Dr. S.P. Nanda 6.Dr. Ravi Kumar Kuna 7.Dr. Karthik Parmanik 8.Prof. M Subba Rao 9.Pamukuntla Mahesh 10.Prof. S. Eswara Reddy.

डिजाइन अधिनियम, 2000 तथा डिजाइन नियम, 2001 के अधधीन प्रावधानों के अनुसरण में।

In pursuance of and subject to the provisions of the Designs Act, 2000 and the Designs Rules, 2001.

जारी करने की तिथि : 14/12/2023
Date of Issue



महानियंत्रक पेटेंट, डिजाइन और व्यापार चिह्न
Controller General of Patents, Designs and Trade Marks

*पारस्परिकता तारीख (यदि कोई हो) जिसकी अनुमति दी गई है तथा देश का नाम। डिजाइन का स्वत्वाधिकार पंजीकरण की तारीख से दस वर्षों के लिए होगा जिसका विस्तार, अधिनियम एवं नियम के निबंधनों के अधीन, पाँच वर्षों की अतिरिक्त अवधि के लिए किया जा सकेगा। इस प्रमाण पत्र का उपयोग विधिक कार्यवाहियों अथवा विदेश में पंजीकरण प्राप्त करने के लिए नहीं हो सकता है।

The reciprocity date (if any) which has been allowed and the name of the country. Copyright in the design will subsist for ten years from the date of Registration, and may under the terms of the Act and Rules, be extended for a further period of five years. This Certificate is not for use in legal proceedings or for obtaining registration abroad.



ORIGINAL
क्रम सं/ Serial No. : 159066



पेटेंट कार्यालय, भारत सरकार

The Patent Office, Government Of India

डिजाइन के पंजीकरण का प्रमाण पत्र

Certificate of Registration of Design

डिजाइन सं. / Design No. : 405198-001

तारीख / Date : 20/01/2024

पारस्परिकता तारीख / Reciprocity Date* :

देश / Country

प्रमाणित किया जाता है कि संलग्न प्रति में वर्णित डिजाइन जो **SPECTRAL STEVIA HARVEST OPTIMIZER** से संबंधित है, का पंजीकरण, श्रेणी 10-05 में 1.Centurion University Of Technology And Management 2. Prof. S. Eswara Reddy 3.Dr. Vangapandu Thriveni 4.Dr. S.P. Nanda 5.Dr. Swapnil 6.Dr. Pamirelli Ranjith 7.Dr. Venkatesh Iddumu 8.Miss. Chandaka Deepti 9.Miss. Saraswati Pati 10.Dr. Goutam B. Hosamani के नाम में उपर्युक्त संख्या और तारीख में कर लिया गया है।

Certified that the design of which a copy is annexed hereto has been registered as of the number and date given above in class 10-05 in respect of the application of such design to **SPECTRAL STEVIA HARVEST OPTIMIZER** in the name of 1.Centurion University Of Technology And Management 2. Prof. S. Eswara Reddy 3.Dr. Vangapandu Thriveni 4.Dr. S.P. Nanda 5.Dr. Swapnil 6.Dr. Pamirelli Ranjith 7.Dr. Venkatesh Iddumu 8.Miss. Chandaka Deepti 9.Miss. Saraswati Pati 10.Dr. Goutam B. Hosamani.

डिजाइन अधिनियम, 2000 तथा डिजाइन नियम, 2001 के अध्याधीन प्रावधानों के अनुसरण में।

In pursuance of and subject to the provisions of the Designs Act, 2000 and the Designs Rules, 2001.

जारी करने की तिथि :
Date of Issue : 01/03/2024



Signature
उत्तम पी शंखर

महानियंत्रक पेटेंट, डिजाइन और व्यापार चिह्न
Controller General of Patents, Designs and Trade Marks

*पारस्परिकता तारीख (यदि कोई हो) जिसकी अनुमति दी गई है तथा देश का नाम। डिजाइन का स्वत्वधिकार पंजीकरण की तारीख से दस वर्षों के लिए होगा जिसका विस्तार, अधिनियम एवं नियम के निबंधनों के अधीन, पाँच वर्षों की अतिरिक्त अवधि के लिए किया जा सकेगा। इस प्रमाण पत्र का उपयोग विधिक कार्यवाहियों अथवा विदेश में पंजीकरण प्राप्त करने के लिए नहीं हो सकता है।
The reciprocity date (if any) which has been allowed and the name of the country. Copyright in the design will subsist for ten years from the date of Registration, and may under the terms of the Act and Rules, be extended for a further period of five years. This Certificate is not for use in legal proceedings or for obtaining registration abroad.



ORIGINAL
क्रम सं/ Serial No. : 150794



पेटेंट कार्यालय, भारत सरकार | The Patent Office, Government Of India

डिजाइन के पंजीकरण का प्रमाण पत्र | Certificate of Registration of Design

डिजाइन सं. / Design No. : 398238-001

तारीख / Date : 22/10/2023

पारस्परिकता तारीख / Reciprocity Date* :

देश / Country :

प्रमाणित किया जाता है कि संलग्न प्रति में वर्णित डिजाइन जो **SMART SYSTEM FOR CHARGING ELECTRIC VEHICLE** से संबंधित है, का पंजीकरण, श्रेणी 13-02 में 1.Dr. Sudhansu Kumar Samal 2. B Neeraja 3.Samraat Sharma 4.Dr. P Arularasan 5.Dr. Vijaykumar S Biradar 6.M.Vijetha 7.Dr. Ram Bajaj 8.Prashanta Kumar Dehury 9.Muneeb Ahmad 10.Dr. Pooja Nagpal के नाम में उपर्युक्त संख्या और तारीख में कर लिया गया है।

Certified that the design of which a copy is annexed hereto has been registered as of the number and date given above in class 13-02 in respect of the application of such design to **SMART SYSTEM FOR CHARGING ELECTRIC VEHICLE** in the name of 1.Dr. Sudhansu Kumar Samal 2. B Neeraja 3.Samraat Sharma 4.Dr. P Arularasan 5.Dr. Vijaykumar S Biradar 6.M.Vijetha 7.Dr. Ram Bajaj 8.Prashanta Kumar Dehury 9.Muneeb Ahmad 10.Dr. Pooja Nagpal.

डिजाइन अधिनियम, 2000 तथा डिजाइन नियम, 2001 के अध्याधीन प्रावधानों के अनुसरण में।

In pursuance of and subject to the provisions of the Designs Act, 2000 and the Designs Rules, 2001.

जारी करने की तिथि : 22/12/2023
Date of Issue



(Signature)

महानियंत्रक पेटेंट, डिजाइन और व्यापार चिह्न
Controller General of Patents, Designs and Trade Marks

*पारस्परिकता तारीख (यदि कोई हो) जिसकी अनुमति दी गई है तथा देश का नाम। डिजाइन का स्वत्वाधिकार पंजीकरण की तारीख से दस वर्षों के लिए होगा जिसका विस्तार, अधिनियम एवं नियम के निबंधनों के अधीन, पाँच वर्षों की अतिरिक्त अवधि के लिए किया जा सकेगा। इस प्रमाण पत्र का उपयोग विधिक कार्यवाहियों अथवा विदेश में पंजीकरण प्राप्त करने के लिए नहीं हो सकता है।

The reciprocity date (if any) which has been allowed and the name of the country. Copyright in the design will subsist for ten years from the date of Registration, and may under the terms of the Act and Rules, be extended for a further period of five years. This Certificate is not for use in legal proceedings or for obtaining registration abroad.

Design Application Details

Application Number:

395437-001

Cbr Number:

211744

Cbr Date:

19/09/2023 22:50:56

Applicant Name:

- | | | |
|-----------------------------|-------------------------|---------------------|
| 1. Dr. Sudhansu Kumar Samal | 2. B Neeraja | 3. Dr. P Arularasan |
| 4. Dr. Periasami Nagappan | 5. Manju Bagga | 6. Shiv Prasad Kori |
| 7. Dr. Chandrabhan Makode | 8. Dr. Rohit Srivastava | 9. Dr. Pooja Nagpal |

Design Application Status

Application Status:

Design Accepted and Published, Journal No is 43/2023 and Journal Date is 27/10/2023

[Back \(/DesignApplicationStatus/\)](#)

Disclaimer: Application status is available for the application filed on or after 1st April 2009 with application no 222230. The information under " Design Application Status" is dynamically retrieved and is under testing, therefore the information retrieved by this system is not valid for any legal proceedings under the Design Act 2000. In case of any discrepancy you may contact the appropriate Patent Office or send your comments to following email IDs:

Design Office, Kolkata : controllerdesign.ipo@nic.in

Controller General of Patents, Designs and Trademarks

Design Application Details

Application Number:	405198-001
Cbr Number:	200952
Cbr Date:	20/01/2024 11:03:44
Applicant Name:	<ol style="list-style-type: none">1. Centurion University of Technology and Management2. Prof. S. Eswara Reddy3. Dr. Vangapandu Thriveni4. Dr. S.P. Nanda5. Dr. Swapnil6. Dr. Pamirelli Ranjith7. Dr. Venkatesh Iddumu8. Miss. Chandaka Deepti9. Miss. Saraswati Pati10. Dr. Goutam B. Hosamani

Design Application Status

Application Status: Application Accepted, Certificate of Design not Generated.

[Back](#)

ORIGINAL

क्रम सं/ Serial No.: 156410

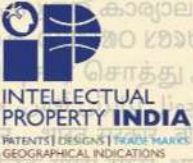

पेटेंट कार्यालय, भारत सरकार

The Patent Office, Government Of India

डिजाइन के पंजीकरण का प्रमाण पत्र

Certificate of Registration of Design

डिजाइन सं. / Design No. 401525-001

तारीख / Date 06/12/2023

पारस्परिकता तारीख / Reciprocity Date*

देश / Country

प्रमाणित किया जाता है कि संलग्न प्रति में वर्णित डिजाइन जो PORTABLE STEVIA HARVEST ANALYSING DEVICE से संबंधित है, का पंजीकरण, श्रेणी 15-03 में 1.Dr. S. Eswara Reddy 2. Dr. Vangapandu Thriveni 3.Dr. S.P. Nanda 4.Dr. M. Devender Reddy 5.Dr. Swapnil 6.Dr. Digvijay Singh 7.Er. Pramod Kumar 8.Dr. Ashutosh Kumar 9.Dr. Achal Kant 10.Dr. Sumit Pal के नाम में उपर्युक्त संख्या और तारीख में कर लिया गया है।

Certified that the design of which a copy is annexed hereto has been registered as of the number and date given above in class 15-03 in respect of the application of such design to PORTABLE STEVIA HARVEST ANALYSING DEVICE in the name of 1.Dr. S. Eswara Reddy 2. Dr. Vangapandu Thriveni 3.Dr. S.P. Nanda 4.Dr. M. Devender Reddy 5.Dr. Swapnil 6.Dr. Digvijay Singh 7.Er. Pramod Kumar 8.Dr. Ashutosh Kumar 9.Dr. Achal Kant 10.Dr. Sumit Pal.

डिजाइन अधिनियम, 2000 तथा डिजाइन नियम, 2001 के अधधीन प्रावधानों के अनुसरण में।

In pursuance of and subject to the provisions of the Designs Act, 2000 and the Designs Rules, 2001.

जारी करने की तिथि : 09/02/2024
Date of Issue



[Signature]

महानियंत्रक पेटेंट, डिजाइन और व्यापार चिह्न
Controller General of Patents, Designs and Trade Marks

*पारस्परिकता तारीख (यदि कोई हो) जिसकी अनुमति दी गई है तथा देश का नाम। डिजाइन का स्वत्वाधिकार पंजीकरण की तारीख से दस वर्षों के लिए होगा जिसका विस्तार, अधिनियम एवं नियम के निबंधनों के अधीन, पाँच वर्षों की अतिरिक्त अवधि के लिए किया जा सकेगा। इस प्रमाण पत्र का उपयोग विधिक कार्यवाहियों अथवा विदेश में पंजीकरण प्राप्त करने के लिए नहीं हो सकता है।
The reciprocity date (if any) which has been allowed and the name of the country. Copyright in the design will subsist for ten years from the date of Registration, and may under the terms of the Act and Rules, be extended for a further period of five years. This Certificate is not for use in legal proceedings or for obtaining registration abroad.

ORIGINAL
क्रम सं/ Serial No.: 156845



सत्यमेव जयते



पेटेंट कार्यालय, भारत सरकार | The Patent Office, Government Of India

डिजाइन के पंजीकरण का प्रमाण पत्र | Certificate of Registration of Design

डिजाइन सं. / Design No. : 403492-001
तारीख / Date : 29/12/2023
पारस्परिकता तारीख / Reciprocity Date* :
देश / Country :

प्रमाणित किया जाता है कि संलग्न प्रति में वर्णित डिजाइन जो **MICROWAVE BASED EQUIPMENT SYNTHESIS OF CHEMICAL COMPOUNDS** से संबंधित है, का पंजीकरण, श्रेणी 24-02 में 1.Dr. Smt. Preeti Gajendra Karade 2. Dr. Senthil Kumar Raju 3.P.S Minhas 4.Dr. G. Muthubhupathi 5.Prof. (Dr.) Varsha Deva 6.Dr. Chinnaamy Balalakshmi 7.Dhanashree Rajkumar Karade 8.Dr. Brijesh Shivhare 9.Mr.Sumit Atmaram Shinde 10.Dr. Sanjay Kumar Yadav 11.Dr. Himansu Bhusan Samal के नाम में उपर्युक्त संख्या और तारीख में कर लिया गया है।

Certified that the design of which a copy is annexed hereto has been registered as of the number and date given above in class 24-02 in respect of the application of such design to **MICROWAVE BASED EQUIPMENT SYNTHESIS OF CHEMICAL COMPOUNDS** in the name of 1.Dr. Smt. Preeti Gajendra Karade 2. Dr. Senthil Kumar Raju 3.P.S Minhas 4.Dr. G. Muthubhupathi 5.Prof. (Dr.) Varsha Deva 6.Dr. Chinnaamy Balalakshmi 7.Dhanashree Rajkumar Karade 8.Dr. Brijesh Shivhare 9.Mr.Sumit Atmaram Shinde 10.Dr. Sanjay Kumar Yadav 11.Dr. Himansu Bhusan Samal.

डिजाइन अधिनियम, 2000 तथा डिजाइन नियम, 2001 के अध्याधीन प्रावधानों के अनुसरण में।
In pursuance of and subject to the provisions of the Designs Act, 2000 and the Designs Rules, 2001.



(Signature)
कुनात की अंसिद

महानियंत्रक पेटेंट, डिजाइन और व्यापार चिह्न
Controller General of Patents, Designs and Trade Marks

*पारस्परिकता तारीख (यदि कोई हो) जिसकी अनुमति दी गई है तथा देश का नाम। डिजाइन का स्वत्वाधिकार पंजीकरण की तारीख से दस वर्षों के लिए होगा जिसका विस्तार, अधिनियम एवं नियम के निबंधनों के अधीन, पाँच वर्षों की अतिरिक्त अवधि के लिए किया जा सकेगा। इस प्रमाण पत्र का उपयोग विधिक कार्यवाहियों अथवा विदेश में पंजीकरण प्राप्त करने के लिए नहीं हो सकता है।
The reciprocity date (if any) which has been allowed and the name of the country. Copyright in the design will subsist for ten years from the date of Registration, and may under the terms of the Act and Rules, be extended for a further period of five years. This Certificate is not for use in legal proceedings or for obtaining registration abroad.



ORIGINAL

क्रम सं/ Serial No. : 153612



पेटेंट कार्यालय, भारत सरकार | The Patent Office, Government Of India

डिजाइन के पंजीकरण का प्रमाण पत्र | Certificate of Registration of Design

डिजाइन सं. / Design No. : 400479-001

तारीख / Date : 22/11/2023

पारस्परिकता तारीख / Reciprocity Date* :

देश / Country

प्रमाणित किया जाता है कि संलग्न प्रति में वर्णित डिजाइन जो **PRECISION FARMING DEVICE** से संबंधित है, का पंजीकरण, श्रेणी 15-03 में 1.Mr. Anil Kumar Jonnalagadda 2. Dr. Vangapandu Thriveni 3.Prof. N. Venugopala Rao 4.Dr. Korla Harshavardhan 5.Dr. Parle Kalyan Chakravarthy 6.Dr. S. Bhargav Kiran 7.Dr. Goutam B. Hosamani 8.Dr. M Sv Satyanarayana 9.Dr. N. Jhansirani 10.Prof. S. Eswara Reddy के नाम में उपर्युक्त संख्या और तारीख में कर लिया गया है।

Certified that the design of which a copy is annexed hereto has been registered as of the number and date given above in class 15-03 in respect of the application of such design to **PRECISION FARMING DEVICE** in the name of 1.Mr. Anil Kumar Jonnalagadda 2. Dr. Vangapandu Thriveni 3.Prof. N. Venugopala Rao 4.Dr. Korla Harshavardhan 5.Dr. Parle Kalyan Chakravarthy 6.Dr. S. Bhargav Kiran 7.Dr. Goutam B. Hosamani 8.Dr. M Sv Satyanarayana 9.Dr. N. Jhansirani 10.Prof. S. Eswara Reddy.

डिजाइन अधिनियम, 2000 तथा डिजाइन नियम, 2001 के अधधीन प्रावधानों के अनुसरण में।

In pursuance of and subject to the provisions of the Designs Act, 2000 and the Designs Rules, 2001.

जारी करने की तिथि : 15/01/2024
Date of Issue



[Signature]

महानियंत्रक पेटेंट, डिजाइन और व्यापार चिह्न
Controller General of Patents, Designs and Trade Marks

*पारस्परिकता तारीख (यदि कोई हो) जिसकी अनुमति दी गई है तथा देश का नाम। डिजाइन का स्वत्वधिकार पंजीकरण की तारीख से दस वर्षों के लिए होगा जिसका विस्तार, अधिनियम एवं नियम के निबंधनों के अधीन, पाँच वर्षों की अतिरिक्त अवधि के लिए किया जा सकेगा। इस प्रमाण पत्र का उपयोग विधिक कार्यवाहियों अथवा विदेश में पंजीकरण प्राप्त करने के लिए नहीं हो सकता है।
The reciprocity date (if any) which has been allowed and the name of the country. Copyright in the design will subsist for ten years from the date of Registration, and may under the terms of the Act and Rules, be extended for a further period of five years. This Certificate is not for use in legal proceedings or for obtaining registration abroad.



ORIGINAL

मूल/No : 122074



भारत सरकार
GOVERNMENT OF INDIA
पेटेंट कार्यालय
THE PATENT OFFICE

डिजाइन के पंजीकरण का प्रमाणपत्र
CERTIFICATE OF REGISTRATION OF DESIGN

डिजाइन सं. / Design No. : 330539-001
तारीख / Date : 29/06/2020
पारस्परिकता तारीख / Reciprocity Date* :
देश / Country :

प्रमाणित किया जाता है कि संलग्न प्रति में वर्णित डिजाइन जो **SAFETY DRONE** से संबंधित है, का पंजीकरण, श्रेणी **12-07** में Centurion University Of Technology & Management (Cutm) के नाम में उपर्युक्त संख्या और तारीख में कर लिया गया है।

Certified that the design of which a copy is annexed hereto has been registered as of the number and date given above in class **12-07** in respect of the application of such design to **SAFETY DRONE** in the name of Centurion University Of Technology & Management (Cutm).

डिजाइन अधिनियम, 2000 तथा डिजाइन नियम, 2001 के अध्याधीन प्रावधानों के अनुसरण में।

In pursuance of and subject to the provisions of the Designs Act, 2000 and the Designs Rules, 2001.

INTELLECTUAL
PROPERTY INDIA
PATENTS | DESIGNS | TRADE MARKS
GEOGRAPHICAL INDICATIONS

निर्गमन की तारीख/Date of Issue : 28/12/2022

महानियंत्रक पेटेंट डिजाइन और व्यापार चिह्न
Controller General of Patents, Designs and Trade Marks

पारस्परिकता तारीख (यदि कोई हो) जिसकी अनुमति देश के नाम पर की गई है। डिजाइन का सत्त्वाधिकार पंजीकरण की तारीख से दस वर्षों के लिए होगा जिसका विस्तार, अधिनियम एवं नियम के निबंधनों के अधीन, पाँच वर्षों की अतिरिक्त अवधि के लिए किया जा सकेगा। इस प्रमाण पत्र का उपयोग विधिक कार्यवाहियों अथवा विदेश में पंजीकरण प्राप्त करने के लिए नहीं हो सकता है।

*The reciprocity date (if any) which has been allowed and the name of the country. Copyright in the design will subsist for ten years from the date of Registration, and may under the terms of the Act and Rules, be extended for a further period of five years. This Certificate is not for use in legal proceedings or for obtaining registration abroad.



ORIGINAL
क्रम सं/ Serial No. : 147689



पेटेंट कार्यालय, भारत सरकार | The Patent Office, Government Of India
डिजाइन के पंजीकरण का प्रमाण पत्र | Certificate of Registration of Design

डिजाइन सं. / Design No. : 339289-001
तारीख / Date : 18/02/2021
पारस्परिकता तारीख / Reciprocity Date* :
देश / Country :

प्रमाणित किया जाता है कि संलग्न प्रति में वर्णित डिजाइन जो **BAMBOO BOTTLE** से संबंधित है, का पंजीकरण, श्रेणी 09-01 में 1.Centurion University Of Technology & Management (Cutm) 2. Dr.Nitesh Dhar Badgayan 3.Mr.E.Krushna Murthy 4.Mr.Jitendra Pramanik के नाम में उपर्युक्त संख्या और तारीख में कर लिया गया है।

Certified that the design of which a copy is annexed hereto has been registered as of the number and date given above in class 09-01 in respect of the application of such design to **BAMBOO BOTTLE** in the name of 1.Centurion University Of Technology & Management (Cutm) 2. Dr.Nitesh Dhar Badgayan 3.Mr.E.Krushna Murthy 4.Mr.Jitendra Pramanik.

डिजाइन अधिनियम, 2000 तथा डिजाइन नियम, 2001 के अध्याधीन प्रावधानों के अनुसरण में।

In pursuance of and subject to the provisions of the Designs Act, 2000 and the Designs Rules, 2001.

जारी करने की तिथि : 06/11/2023
Date of Issue :



[Signature]

महानियंत्रक पेटेंट, डिजाइन और व्यापार चिह्न
Controller General of Patents, Designs and Trade Marks

*पारस्परिकता तारीख (यदि कोई हो) जिसकी अनुमति दी गई है तथा देश का नाम। डिजाइन का स्वत्वाधिकार पंजीकरण की तारीख से दस वर्षों के लिए होगा जिसका विस्तार, अधिनियम एवं नियम के निबंधनों के अधीन, पाँच वर्षों की अतिरिक्त अवधि के लिए किया जा सकेगा। इस प्रमाण पत्र का उपयोग विधिक कार्यवाहियों अथवा विदेश में पंजीकरण प्राप्त करने के लिए नहीं हो सकता है।
The reciprocity date (if any) which has been allowed and the name of the country. Copyright in the design will subsist for ten years from the date of Registration, and may under the terms of the Act and Rules, be extended for a further period of five years. This Certificate is not for use in legal proceedings or for obtaining registration abroad.



ORIGINAL

मूल/No : 130752



भारत सरकार
GOVERNMENT OF INDIA
पेटेंट कार्यालय
THE PATENT OFFICE

डिजाइन के पंजीकरण का प्रमाणपत्र
CERTIFICATE OF REGISTRATION OF DESIGN

डिजाइन सं. / Design No.	:	357341-001
तारीख / Date	:	26/01/2022
पारस्परिकता तारीख / Reciprocity Date*	:	
देश / Country	:	

प्रमाणित किया जाता है कि संलग्न प्रति में वर्णित डिजाइन जो SEAT से संबंधित है, का पंजीकरण, श्रेणी 06-01 में 1. Centurion University Of Technology & Management (Cutm) 2. Parthasarathi Mohanty के नाम में उपर्युक्त संख्या और तारीख में कर लिया गया है।

Certified that the design of which a copy is annexed hereto has been registered as of the number and date given above in class 06-01 in respect of the application of such design to SEAT in the name of 1. Centurion University Of Technology & Management (Cutm) 2. Parthasarathi Mohanty.

डिजाइन अधिनियम, 2000 तथा डिजाइन नियम, 2001 के अध्याधीन प्रावधानों के अनुसरण में।

In pursuance of and subject to the provisions of the Designs Act, 2000 and the Designs Rules, 2001.

INTELLECTUAL
PROPERTY INDIA
PATENTS | DESIGNS | TRADE MARKS
GEOGRAPHICAL INDICATIONS

निर्गमन की तारीख/Date of Issue : 13/03/2023

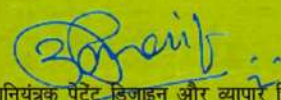
महानियंत्रक पेटेंट डिजाइन और व्यापार चिह्न
Controller General of Patents, Designs and Trade Marks

पारस्परिकता तारीख (यदि कोई हो) जिसकी अनुमति देश के नाम पर की गई है। डिजाइन का सत्वाधिकार पंजीकरण की तारीख से दस वर्षों के लिए होगा जिसका विस्तार, अधिनियम एवं नियम के निबंधनों के अधीन, पाँच वर्षों की अतिरिक्त अवधि के लिए किया जा सकेगा। इस प्रमाण पत्र का उपयोग विधिक कार्यवाहियों अथवा विदेश में पंजीकरण प्राप्त करने के लिए नहीं हो सकता है।

*The reciprocity date (if any) which has been allowed and the name of the country. Copyright in the design will subsist for ten years from the date of Registration, and may under the terms of the Act and Rules, be extended for a further period of five years. This Certificate is not for use in legal proceedings or for obtaining registration abroad.

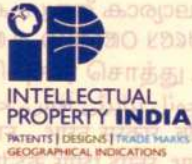

ORIGINAL
क्रम सं/ Serial No. : 140081



पेटेंट कार्यालय, भारत सरकार | The Patent Office, Government Of India

डिजाइन के पंजीकरण का प्रमाण पत्र | Certificate of Registration of Design

डिजाइन सं. / Design No. : 357342-001

तारीख / Date : 26/01/2022

पारस्परिकता तारीख / Reciprocity Date* :

देश / Country :

प्रमाणित किया जाता है कि संलग्न प्रति में वर्णित डिजाइन जो **FOLDABLE TABLE** से संबंधित है, का पंजीकरण, श्रेणी 06-03 में 1. Centurion University Of Technology & Management (Cutm) 2. Parthasarathi Mohanty के नाम में उपर्युक्त संख्या और तारीख में कर लिया गया है।

Certified that the design of which a copy is annexed hereto has been registered as of the number and date given above in class 06-03 in respect of the application of such design to **FOLDABLE TABLE** in the name of 1. Centurion University Of Technology & Management (Cutm) 2. Parthasarathi Mohanty.

डिजाइन अधिनियम, 2000 तथा डिजाइन नियम, 2001 के अध्याधीन प्रावधानों के अनुसरण में।

In pursuance of and subject to the provisions of the Designs Act, 2000 and the Designs Rules, 2001.

जारी करने की तिथि : 03/07/2023
Date of Issue :



महानियंत्रक पेटेंट, डिजाइन और व्यापार चिह्न
Controller General of Patents, Designs and Trade Marks

*पारस्परिकता तारीख (यदि कोई हो) जिसकी अनुमति दी गई है तथा देश का नाम। डिजाइन का स्वत्वाधिकार पंजीकरण की तारीख से दस वर्षों के लिए होगा जिसका विस्तार, अधिनियम एवं नियम के निबंधनों के अधीन, पाँच वर्षों की अतिरिक्त अवधि के लिए किया जा सकेगा। इस प्रमाण पत्र का उपयोग विधिक कार्यवाहियों अथवा विदेश में पंजीकरण प्राप्त करने के लिए नहीं हो सकता है।
The reciprocity date (if any) which has been allowed and the name of the country. Copyright in the design will subsist for ten years from the date of Registration, and may under the terms of the Act and Rules, be extended for a further period of five years. This Certificate is not for use in legal proceedings or for obtaining registration abroad.



ORIGINAL

मूल/No : 130244



भारत सरकार
GOVERNMENT OF INDIA
पेटेंट कार्यालय
THE PATENT OFFICE

डिजाइन के पंजीकरण का प्रमाणपत्र
CERTIFICATE OF REGISTRATION OF DESIGN

डिजाइन सं. / Design No. : 357343-001
तारीख / Date : 26/01/2022
पारस्परिकता तारीख / Reciprocity Date* :
देश / Country :

प्रमाणित किया जाता है कि संलग्न प्रति में वर्णित डिजाइन जो **WRITABLE TABLE** से संबंधित है, का पंजीकरण, श्रेणी **06-03** में 1. Centurion University Of Technology & Management (Cutm) 2. Parthasarathi Mohanty के नाम में उपर्युक्त संख्या और तारीख में कर लिया गया है।

Certified that the design of which a copy is annexed hereto has been registered as of the number and date given above in class **06-03** in respect of the application of such design to **WRITABLE TABLE** in the name of 1. Centurion University Of Technology & Management (Cutm) 2. Parthasarathi Mohanty.

डिजाइन अधिनियम, 2000 तथा डिजाइन नियम, 2001 के अध्याधीन प्रावधानों के अनुसरण में।

In pursuance of and subject to the provisions of the Designs Act, 2000 and the Designs Rules, 2001.

INTELLECTUAL
PROPERTY INDIA
PATENTS | DESIGNS | TRADE MARKS
GEOGRAPHICAL INDICATIONS

निर्गमन की तारीख/Date of Issue : 06/03/2023

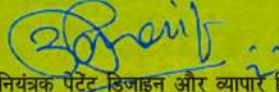
महानियंत्रक पेटेंट डिजाइन और व्यापार चिह्न
Controller General of Patents, Designs and Trade Marks

पारस्परिकता तारीख (यदि कोई हो) जिसकी अनुमति देश के नाम पर की गई है। डिजाइन का सत्वाधिकार पंजीकरण की तारीख से दस वर्षों के लिए होगा जिसका विस्तार, अधिनियम एवं नियम के निबंधनों के अधीन, पाँच वर्षों की अतिरिक्त अवधि के लिए किया जा सकेगा। इस प्रमाण पत्र का उपयोग विधिक कार्यवाहियों अथवा विदेश में पंजीकरण प्राप्त करने के लिए नहीं हो सकता है।

*The reciprocity date (if any) which has been allowed and the name of the country. Copyright in the design will subsist for ten years from the date of Registration, and may under the terms of the Act and Rules, be extended for a further period of five years. This Certificate is not for use in legal proceedings or for obtaining registration abroad.



ORIGINAL
क्रम सं/ Serial No. : 145741



पेटेंट कार्यालय, भारत सरकार

The Patent Office, Government Of India

डिजाइन के पंजीकरण का प्रमाण पत्र

Certificate of Registration of Design

डिजाइन सं. / Design No. : 374950-001

तारीख / Date : 02/12/2022

पारस्परिकता तारीख / Reciprocity Date* :

देश / Country :

प्रमाणित किया जाता है कि संलग्न प्रति में वर्णित डिजाइन जो **POLYCENTRIC KNEE JOINT** से संबंधित है, का पंजीकरण, श्रेणी 24-04 में 1. Centurion University Of Technology And Management (Cutm) 2. Rajesh Kumar Mohanty 3.R.C. Mohanty 4.Sukanta Kumar Sabut के नाम में उपर्युक्त संख्या और तारीख में कर लिया गया है।

Certified that the design of which a copy is annexed hereto has been registered as of the number and date given above in class 24-04 in respect of the application of such design to **POLYCENTRIC KNEE JOINT** in the name of 1. Centurion University Of Technology And Management (Cutm) 2. Rajesh Kumar Mohanty 3.R.C. Mohanty 4.Sukanta Kumar Sabut.

डिजाइन अधिनियम, 2000 तथा डिजाइन नियम, 2001 के अध्याधीन प्रावधानों के अनुसरण में।

In pursuance of and subject to the provisions of the Designs Act, 2000 and the Designs Rules, 2001.

जारी करने की तिथि : 12/10/2023
Date of Issue :



महानियंत्रक पेटेंट, डिजाइन और व्यापार चिह्न
Controller General of Patents, Designs and Trade Marks

*पारस्परिकता तारीख (यदि कोई हो) जिसकी अनुमति दी गई है तथा देश का नाम। डिजाइन का स्वत्वाधिकार पंजीकरण की तारीख से दस वर्षों के लिए होगा जिसका विस्तार, अधिनियम एवं नियम के निबंधनों के अधीन, पाँच वर्षों की अतिरिक्त अवधि के लिए किया जा सकेगा। इस प्रमाण पत्र का उपयोग विधिक कार्यवाहियों अथवा विदेश में पंजीकरण प्राप्त करने के लिए नहीं हो सकता है।
The reciprocity date (if any) which has been allowed and the name of the country. Copyright in the design will subsist for ten years from the date of Registration, and may under the terms of the Act and Rules, be extended for a further period of five years. This Certificate is not for use in legal proceedings or for obtaining registration abroad.



ORIGINAL

क्रम सं/ Serial No. : 16774



पेटेंट कार्यालय, भारत सरकार | The Patent Office, Government Of India

डिजाइन के पंजीकरण का प्रमाण पत्र | Certificate of Registration of Design

डिजाइन सं. / Design No. 410293-001

तारीख / Date 12/03/2024

पारस्परिकता तारीख / Reciprocity Date*

देश / Country

प्रमाणित किया जाता है कि संलग्न प्रति में वर्णित डिजाइन जो STEVIA LEAVES SORTING MACHINE से संबंधित है, का पंजीकरण, श्रेणी 15-03 में 1.Centurion University Of Technology And Management 2. Prof. D.N Rao 3.Prof. S.P. Nanda 4.Prof. Anita Patra 5.Prof. Durga Prasad Padhi 6.Prof. N. Venugopala Rao 7.Dr. Chitrasena Padhy 8.Dr. Vangapandu Thriveni 9.Dr. Swapnil 10.Prof. S. Eswara Reddy के नाम में उपर्युक्त संख्या और तारीख में कर लिया गया है।

Certified that the design of which a copy is annexed hereto has been registered as of the number and date given above in class 15-03 in respect of the application of such design to STEVIA LEAVES SORTING MACHINE in the name of 1.Centurion University Of Technology And Management 2. Prof. D.N Rao 3.Prof. S.P. Nanda 4.Prof. Anita Patra 5.Prof. Durga Prasad Padhi 6.Prof. N. Venugopala Rao 7.Dr. Chitrasena Padhy 8.Dr. Vangapandu Thriveni 9.Dr. Swapnil 10.Prof. S. Eswara Reddy.

डिजाइन अधिनियम, 2000 तथा डिजाइन नियम, 2001 के अधधीन प्रावधानों के अनुसरण में।

In pursuance of and subject to the provisions of the Designs Act, 2000 and the Designs Rules, 2001.

जारी करने की तिथि : 03/05/2024



इब्राहिम की रांडेव

महानियंत्रक पेटेंट, डिजाइन और व्यापार चिह्न Controller General of Patents, Designs and Trade Marks

*पारस्परिकता तारीख (यदि कोई हो) जिसकी अनुमति दी गई है तथा देश का नाम। डिजाइन का स्वत्वाधिकार पंजीकरण की तारीख से दस वर्षों के लिए होगा जिसका विस्तार, अधिनियम एवं नियम के निबंधनों के अधीन, पाँच वर्षों की अतिरिक्त अवधि के लिए किया जा सकेगा। इस प्रमाण पत्र का उपयोग विधिक कार्यवाहियों अथवा विदेश में पंजीकरण प्राप्त करने के लिए नहीं हो सकता है। The reciprocity date (if any) which has been allowed and the name of the country. Copyright in the design will subsist for ten years from the date of Registration, and may under the terms of the Act and Rules, be extended for a further period of five years. This Certificate is not for use in legal proceedings or for obtaining registration abroad.



ORIGINAL
क्रम सं/ Serial No. : 170969



पेटेंट कार्यालय, भारत सरकार

The Patent Office, Government Of India

डिजाइन के पंजीकरण का प्रमाण पत्र | Certificate of Registration of Design

डिजाइन सं. / Design No. : 413375-001

तारीख / Date : 12/04/2024

पारस्परिकता तारीख / Reciprocity Date* :

देश / Country :

प्रमाणित किया जाता है कि संलग्न प्रति में वर्णित डिजाइन जो *MICROFLUIDIZER APPARATUS FOR NANOPARTICLE SYNTHESIS* से संबंधित है, का पंजीकरण, श्रेणी 24-02 में 1.Centurion University Of Technology And Management 2. Dr. Fahima Dilnawaz 3.Dr. Himansu Bhusan Samal 4.Dr.Pratap Kumar Patra 5.Dr. Gyanranjan Mahalik 6.Mr. Nigam Sekhar Tripathy 7.Ms. Liza Sahoo 8.Mr. Safal Kumar Paikray के नाम में उपर्युक्त संख्या और तारीख में कर लिया गया है।

Certified that the design of which a copy is annexed hereto has been registered as of the number and date given above in class 24-02 in respect of the application of such design to *MICROFLUIDIZER APPARATUS FOR NANOPARTICLE SYNTHESIS* in the name of 1.Centurion University Of Technology And Management 2. Dr. Fahima Dilnawaz 3.Dr. Himansu Bhusan Samal 4.Dr.Pratap Kumar Patra 5.Dr. Gyanranjan Mahalik 6.Mr. Nigam Sekhar Tripathy 7.Ms. Liza Sahoo 8.Mr. Safal Kumar Paikray.

डिजाइन अधिनियम, 2000 तथा डिजाइन नियम, 2001 के अधधीन प्रावधानों के अनुसरण में।

In pursuance of and subject to the provisions of the Designs Act, 2000 and the Designs Rules, 2001.

जारी करने की तिथि : 29/05/2024
Date of Issue



कुमार की अंसि

महानियंत्रक पेटेंट, डिजाइन और व्यापार चिह्न
Controller General of Patents, Designs and Trade Marks

*पारस्परिकता तारीख (यदि कोई हो) जिसकी अनुमति दी गई है तथा देश का नाम। डिजाइन का स्वत्वाधिकार पंजीकरण की तारीख से दस वर्षों के लिए होगा जिसका विस्तार, अधिनियम एवं नियम के निबंधनों के अधीन, पाँच वर्षों की अतिरिक्त अवधि के लिए किया जा सकेगा। इस प्रमाण पत्र का उपयोग विधिक कार्यवाहियों अथवा विदेश में पंजीकरण प्राप्त करने के लिए नहीं हो सकता है।

The reciprocity date (if any) which has been allowed and the name of the country. Copyright in the design will subsist for ten years from the date of Registration, and may under the terms of the Act and Rules, be extended for a further period of five years. This Certificate is not for use in legal proceedings or for obtaining registration abroad.

ORIGINAL
क्रम सं/ Serial No.: 176669



पेटेंट कार्यालय, भारत सरकार

The Patent Office, Government Of India

डिजाइन के पंजीकरण का प्रमाण पत्र

Certificate of Registration of Design

डिजाइन सं. / Design No. : 412526-001

तारीख / Date : 04/04/2024

पारस्परिकता तारीख / Reciprocity Date* :

देश / Country :

प्रमाणित किया जाता है कि संलग्न प्रति में वर्णित डिजाइन जो AI BASED IMAGE-GUIDED RADIATION THERAPY DEVICE से संबंधित है, का पंजीकरण, श्रेणी 24-02 में 1.Centurion University Of Technology And Management 2. Dr. Himansu Bhusan Samal 3.Dr. Fahima Dilnawaz 4.Mr. Nigam Sekhar Tripathy 5.Ms. Liza Sahoo 6.Mr. Safal Kumar Paikray 7.Ms. Sushreesambita Swain 8.Mr. Debashis Mishra 9.Mr. Jagatjit Das 10.Ms. Rojalika Mohanty के नाम में उपर्युक्त संख्या और तारीख में कर लिया गया है।

Certified that the design of which a copy is annexed hereto has been registered as of the number and date given above in class 24-02 in respect of the application of such design to AI BASED IMAGE-GUIDED RADIATION THERAPY DEVICE in the name of 1.Centurion University Of Technology And Management 2. Dr. Himansu Bhusan Samal 3.Dr. Fahima Dilnawaz 4.Mr. Nigam Sekhar Tripathy 5.Ms. Liza Sahoo 6.Mr. Safal Kumar Paikray 7.Ms. Sushreesambita Swain 8.Mr. Debashis Mishra 9.Mr. Jagatjit Das 10.Ms. Rojalika Mohanty.

डिजाइन अधिनियम, 2000 तथा डिजाइन नियम, 2001 के अध्याधीन प्रावधानों के अनुसरण में।

In pursuance of and subject to the provisions of the Designs Act, 2000 and the Designs Rules, 2001.

जारी करने की तिथि : 30/07/2024
Date of Issue

महानियंत्रक पेटेंट, डिजाइन और व्यापार चिह्न
Controller General of Patents, Designs and Trade Marks



कृपल की अंसिद

*पारस्परिकता तारीख (यदि कोई हो) जिसकी अनुमति दी गई है तथा देश का नाम। डिजाइन का स्वत्वाधिकार पंजीकरण की तारीख से दस वर्षों के लिए होगा जिसका विस्तार, अधिनियम एवं नियम के निबंधनों के अधीन, पाँच वर्षों की अतिरिक्त अवधि के लिए किया जा सकेगा। इस प्रमाण पत्र का उपयोग विधिक कार्यवाहियों अथवा विदेश में पंजीकरण प्राप्त करने के लिए नहीं हो सकता है।
The reciprocity date (if any) which has been allowed and the name of the country. Copyright in the design will subsist for ten years from the date of Registration, and may under the terms of the Act and Rules, be extended for a further period of five years. This Certificate is not for use in legal proceedings or for obtaining registration abroad.

Design Application Details

Application Number:

407255-001

Cbr Number:

202257

Cbr Date:

12/02/2024 15:25:00

Applicant Name:

1. Centurion University of Technology & Management 2. Dr. Mukundjee Pandey
3. Ms. Ipsita Mishra 4. Mr. Tapas Kumar Panda 5. Mr. Madhusudan Pandey
6. Dr. Ardhendu Mouli Mohanty

Design Application Status

Application Status:

Design Accepted and Published, Journal No is 15/2024 and Journal Date is 12/04/2024

[Back \(/DesignApplicationStatus/\)](#)

Disclaimer: Application status is available for the application filed on or after 1st April 2009 with application no 222230. The information under " Design Application Status" is dynamically retrieved and is under testing, therefore the information retrieved by this system is not valid for any legal proceedings under the Design Act 2000. In case of any discrepancy you may contact the appropriate Patent Office or send your comments to following email IDs:

Design Office, Kolkata : controllerdesign.ipo@nic.in

Controller General of Patents, Designs and Trademarks

Design Application Details

Application Number:

401536-001

Cbr Number:

215463

Cbr Date:

06/12/2023 18:06:49

Applicant Name:

- | | | |
|-----------------------|--------------------------|----------------------------|
| 1. Dr. Anita Patra | 2. Dr. S. Eswara Reddy | 3. Dr. Vangapandu Thriveni |
| 4. Dr. S.P. Nanda | 5. Dr. M. Devender Reddy | 6. Dr. Swapnil |
| 7. Dr. Digvijay Singh | 8. Dr. Anuradha Sinha | 9. Dr. Ashutosh Kumar |
| 10. Dr. Achal Kant | | |

Design Application Status

Application Status:

Examination Report has been Generated ,Online Reply Document Recived(FER generated on 24/01/2024)

[Back \(/DesignApplicationStatus/\)](#)

Disclaimer: Application status is available for the application filed on or after 1st April 2009 with application no 222230. The information under " Design Application Status" is dynamically retrieved and is under testing, therefore the information retrieved by this system is not valid for any legal proceedings under the Design Act 2000. In case of any discrepancy you may contact the appropriate Patent Office or send your comments to following email IDs:

Design Office, Kolkata : controllerdesign.ipo@nic.in

Controller General of Patents, Designs and Trademarks

Design Application Details

Application Number:

410986-001

Cbr Number:

204598

Cbr Date:

19/03/2024 18:32:38

Applicant Name:

1. PRAKASH KUMAR NAYAK 2. PRATYUSH SAIKIA
3. RADHA KRISHNAN KESAVAN 4. TAPAS MISHRA 5. DEEPANKA SAIKIA

Design Application Status

Application Status:

Design Accepted and Published, Journal No is 20/2024 and Journal Date is 17/05/2024

[Back \(/DesignApplicationStatus/\)](/DesignApplicationStatus/)

Disclaimer: Application status is available for the application filed on or after 1st April 2009 with application no 222230. The information under " Design Application Status" is dynamically retrieved and is under testing, therefore the information retrieved by this system is not valid for any legal proceedings under the Design Act 2000. In case of any discrepancy you may contact the appropriate Patent Office or send your comments to following email IDs:

Design Office, Kolkata : controllerdesign.ipo@nic.in

Controller General of Patents, Designs and Trademarks

Design Application Details

Application Number:

401525-001

Cbr Number:

215457

Cbr Date:

06/12/2023 17:17:00

Applicant Name:

1. Dr. S. Eswara Reddy
2. Dr. Vangapandu Thriveni
3. Dr. S.P. Nanda
4. Dr. M. Devender Reddy
5. Dr. Swapnil
6. Dr. Digvijay Singh
7. Er. Pramod Kumar
8. Dr. Ashutosh Kumar
9. Dr. Achal Kant
10. Dr. Sumit Pal

Design Application Status

Application Status:

Design Accepted and Published, Journal No is 06/2024 and Journal Date is 09/02/2024

[Back \(/DesignApplicationStatus/\)](#)

Disclaimer: Application status is available for the application filed on or after 1st April 2009 with application no 222230. The information under " Design Application Status" is dynamically retrieved and is under testing, therefore the information retrieved by this system is not valid for any legal proceedings under the Design Act 2000. In case of any discrepancy you may contact the appropriate Patent Office or send your comments to following email IDs:

Design Office, Kolkata : controllerdesign.ipo@nic.in

Controller General of Patents, Designs and Trademarks

Design Application Details

Application Number:

410293-001

Cbr Number:

204130

Cbr Date:

12/03/2024 18:59:06

Applicant Name:

1. Centurion University of Technology and Management
2. Prof. D.N Rao
3. Prof. S.P. Nanda
4. Prof. Anita Patra
5. Prof. Durga Prasad Padhi
6. Prof. N. Venugopala Rao
7. Dr. Chitrasena Padhy
8. Dr. Vangapandu Thriveni
9. Dr. Swapnil
10. Prof. S. Eswara Reddy

Design Application Status

Application Status:

Design Accepted and Published, Journal No is 18/2024 and Journal Date is 03/05/2024

[Back \(/DesignApplicationStatus/\)](#)

Disclaimer: Application status is available for the application filed on or after 1st April 2009 with application no 222230. The information under " Design Application Status" is dynamically retrieved and is under testing, therefore the information retrieved by this system is not valid for any legal proceedings under the Design Act 2000. In case of any discrepancy you may contact the appropriate Patent Office or send your comments to following email IDs:

Design Office, Kolkata : controllerdesign.ipo@nic.in

Controller General of Patents, Designs and Trademarks

Design Application Details

Application Number:

417266-001

Cbr Number:

208491

Cbr Date:

17/05/2024 18:08:31

Applicant Name:

1. Centurion University of Technology and Management
2. Prof. D.N Rao
3. Prof. Chinthamani Panda
4. Dr. S.P. Nanda
5. Prof. N. Venugopala Rao
6. Prof. Anita Patra
7. Dr. Alla Devi Vara Prasad Reddy
8. Dr. Mangesh M Bhosale
9. Dr. Mehazabeen. A
10. Dr. Vangapandu Thriveni
11. Prof. S. Eswara Reddy

Design Application Status

Application Status:

Design Accepted and Published, Journal No is 28/2024 and Journal Date is 12/07/2024

[Back \(/DesignApplicationStatus/\)](#)

Disclaimer: Application status is available for the application filed on or after 1st April 2009 with application no 222230. The information under " Design Application Status" is dynamically retrieved and is under testing, therefore the information retrieved by this system is not valid for any legal proceedings under the Design Act 2000. In case of any discrepancy you may contact the appropriate Patent Office or send your comments to following email IDs:

Design Office, Kolkata : controllerdesign.ipo@nic.in

Controller General of Patents, Designs and Trademarks



Intellectual
Property
Office

Certificate of Registration for a UK Design

Design number: 6360790

Grant date: 24 April 2024

Registration date: 19 April 2024

This is to certify that,

in pursuance of and subject to the provision of Registered Designs Act 1949, the design of which a representation or specimen is attached, had been registered as of the date of registration shown above in the name of

Dr. Bhairaba Kumar Majhi, Dr. Shantanu Bhattacharyya, Prof. (Dr.) Biplab Kumar

Sarkar, Mr. Pawan Kumar Singh, Prof. (Dr.) Reena Singh

in respect of the application of such design to:

QUANTUM COMPUTING MACHINE

International Design Classification:

Version: 14-2023

Class: 14 RECORDING, TELECOMMUNICATION OR DATA PROCESSING
EQUIPMENT

Subclass: 02 DATA PROCESSING EQUIPMENT AS WELL AS PERIPHERAL
APPARATUS AND DEVICES

Adam Williams

Comptroller-General of Patents, Designs and Trade Marks
Intellectual Property Office

The attention of the Proprietor(s) is drawn to the important notes overleaf.





Intellectual
Property
Office

Certificate of Registration for a UK Design

Design number: 6371193

Grant date: 17 June 2024

Registration date: 08 June 2024

This is to certify that,

in pursuance of and subject to the provision of Registered Designs Act 1949, the design of which a representation or specimen is attached, had been registered as of the date of registration shown above in the name of

Dr. Shantanu Bhattacharyya, Dr. Pratibha Rani Deep, Dr. Bhairaba Kumar Majhi,

Dr. Saurav Barman, Dr. Nilanjana Datta, Mr. Sameer Kumar Barik, Dr. Katuri

Venkata Prasad, Miss. Leepsa Nanda, Dr. Jyoti Prakash Rath, Mrs. Namita

Panda

in respect of the application of such design to:

Soil and Crop Enhancing Robotic Device

International Design Classification:

Version: 14-2023

Class: 15 MACHINES, NOT ELSEWHERE SPECIFIED

Subclass: 03 AGRICULTURAL AND FORESTRY MACHINERY

Adam Williams

Comptroller-General of Patents, Designs and Trade Marks

Intellectual Property Office

The attention of the Proprietor(s) is drawn to the important notes overleaf.



Design Application Details

Application Number:

405198-001

Cbr Number:

200952

Cbr Date:

20/01/2024 11:03:44

Applicant Name:

1. Centurion University of Technology and Management
2. Prof. S. Eswara Reddy
3. Dr. Vangapandu Thriveni
4. Dr. S.P. Nanda
5. Dr. Swapnil
6. Dr. Pamirelli Ranjith
7. Dr. Venkatesh Iddumu
8. Miss. Chandaka Deepti
9. Miss. Saraswati Pati
10. Dr. Goutam B. Hosamani

Design Application Status

Application Status:

Design Accepted and Published, Journal No is 09/2024 and Journal Date is 01/03/2024

[Back \(/DesignApplicationStatus/\)](#)

Disclaimer: Application status is available for the application filed on or after 1st April 2009 with application no 222230. The information under " Design Application Status" is dynamically retrieved and is under testing, therefore the information retrieved by this system is not valid for any legal proceedings under the Design Act 2000. In case of any discrepancy you may contact the appropriate Patent Office or send your comments to following email IDs:

Design Office, Kolkata : controllerdesign.ipo@nic.in

Controller General of Patents, Designs and Trademarks

Design Application Details

Application Number:

406172-001

Cbr Number:

201608

Cbr Date:

31/01/2024 16:58:27

Applicant Name:

1. Centurion University of Technology and Management
2. Dr. Vangapandu Thriveni
3. Prof. S.P. Nanda
4. Dr. Swapnil
5. Prof. M.Devender Reddy
6. Mr.Anil Kumar Jonnalagadda
7. Dr.S.Bhargav Kiran
8. Prof. N.Venugopala Rao
9. Dr. M SV Satyanarayana
10. Prof. S.Eswara Reddy

Design Application Status

Application Status:

Design Accepted and Published, Journal No is 14/2024 and Journal Date is 05/04/2024

[Back \(/DesignApplicationStatus/\)](#)

Disclaimer: Application status is available for the application filed on or after 1st April 2009 with application no 222230. The information under " Design Application Status" is dynamically retrieved and is under testing, therefore the information retrieved by this system is not valid for any legal proceedings under the Design Act 2000. In case of any discrepancy you may contact the appropriate Patent Office or send your comments to following email IDs:

Design Office, Kolkata : controllerdesign.ipo@nic.in

Controller General of Patents, Designs and Trademarks

Design Application Details

Application Number:

414668-001

Cbr Number:

206798

Cbr Date:

24/04/2024 14:07:05

Applicant Name:

1. Centurion University of Technology and Management
2. Prof. D.N Rao
3. Prof. Pushpalatha Ganesh
4. Prof. N. Venugopala Rao
5. Miss. Chandaka Deepthi
6. Miss Mandapati Roja
7. Dr. M. Shyam Prasad
8. Dr. Srinu Rathlavath
9. Dr. Vangapandu Thriveni
10. Prof. Anil Kumar Jonnalagadda
11. Prof. S. Eswara Reddy

Design Application Status

Application Status:

Design Accepted and Published, Journal No is 23/2024 and Journal Date is 07/06/2024

[Back \(/DesignApplicationStatus/\)](/DesignApplicationStatus/)

Disclaimer: Application status is available for the application filed on or after 1st April 2009 with application no 222230. The information under " Design Application Status" is dynamically retrieved and is under testing, therefore the information retrieved by this system is not valid for any legal proceedings under the Design Act 2000. In case of any discrepancy you may contact the appropriate Patent Office or send your comments to following email IDs:

Design Office, Kolkata : controllerdesign.ipo@nic.in

Controller General of Patents, Designs and Trademarks

Design Application Details

Application Number:

415260-001

Cbr Number:

207140

Cbr Date:

29/04/2024 17:21:53

Applicant Name:

1. Centurion University of Technology and Management
2. Dr. Rahul Adhikary,
3. Dr. Arunabha Pal,
4. Mr. Biswojit Mishra,
5. Ms. Subhashree Subhasmita Paikaray
6. Ms. P.Bhavana,
7. Mr. Chandan Kumar Panigrahi,

Design Application Status

Application Status:

Design Accepted and Published, Journal No is 24/2024 and Journal Date is 14/06/2024

[Back \(/DesignApplicationStatus/\)](#)

Disclaimer: Application status is available for the application filed on or after 1st April 2009 with application no 222230. The information under " Design Application Status" is dynamically retrieved and is under testing, therefore the information retrieved by this system is not valid for any legal proceedings under the Design Act 2000. In case of any discrepancy you may contact the appropriate Patent Office or send your comments to following email IDs:

Design Office, Kolkata : controllerdesign.ipo@nic.in

Controller General of Patents, Designs and Trademarks

Design Application Details

Application Number:

398414-001

Cbr Number:

213497

Cbr Date:

25/10/2023 21:05:52

Applicant Name:

1. Dr. Srikanta Moharana
2. Dr. Shantanu Bhattacharya
3. Dr. Santosh K Satpathy
4. Dr. Bibhuti B. Sahu
5. Dr. Anupam Sahoo
6. Anita Samal

Design Application Status

Application Status:

Design Accepted and Published, Journal No is 12/2024 and Journal Date is 22/03/2024

[Back \(/DesignApplicationStatus/\)](#)

Disclaimer: Application status is available for the application filed on or after 1st April 2009 with application no 222230. The information under " Design Application Status" is dynamically retrieved and is under testing, therefore the information retrieved by this system is not valid for any legal proceedings under the Design Act 2000. In case of any discrepancy you may contact the appropriate Patent Office or send your comments to following email IDs:

Design Office, Kolkata : controllerdesign.ipo@nic.in

Controller General of Patents, Designs and Trademarks

Design Application Details

Application Number:

412526-001

Cbr Number:

205561

Cbr Date:

04/04/2024 09:05:27

Applicant Name:**1. Centurion University of Technology and Management****2. Dr. Himansu Bhusan Samal****3. Dr. Fahima Dilnawaz****4. Mr. Nigam Sekhar Tripathy****5. Ms. Liza Sahoo****6. Mr. Safal Kumar Paikray****7. Ms. Sushreesambita Swain****8. Mr. Debashis Mishra****9. Mr. Jagatjit Das****10. Ms. Rojalika Mohanty**

Design Application Status

Application Status:

Design Accepted and Published, Journal No is 31/2024 and Journal Date is 02/08/2024

[Back \(/DesignApplicationStatus/\)](#)

Disclaimer: Application status is available for the application filed on or after 1st April 2009 with application no 222230. The information under " Design Application Status" is dynamically retrieved and is under testing, therefore the information retrieved by this system is not valid for any legal proceedings under the Design Act 2000. In case of any discrepancy you may contact the appropriate Patent Office or send your comments to following email IDs:

Design Office, Kolkata : controllerdesign.ipo@nic.in

Controller General of Patents, Designs and Trademarks

Design Application Details

Application Number:

413375-001

Cbr Number:

206111

Cbr Date:

12/04/2024 19:15:30

Applicant Name:

1. Centurion University of Technology and Management
2. Dr. Fahima Dilnawaz
3. Dr. Himansu Bhusan Samal
4. Dr. Pratap Kumar Patra
5. Dr. Gyanranjan Mahalik
6. Mr. Nigam Sekhar Tripathy
7. Ms. Liza Sahoo
8. Mr. Safal Kumar Paikray

Design Application Status

Application Status:

Design Accepted and Published, Journal No is 22/2024 and Journal Date is 31/05/2024

[Back \(/DesignApplicationStatus/\)](#)

Disclaimer: Application status is available for the application filed on or after 1st April 2009 with application no 222230. The information under " Design Application Status" is dynamically retrieved and is under testing, therefore the information retrieved by this system is not valid for any legal proceedings under the Design Act 2000. In case of any discrepancy you may contact the appropriate Patent Office or send your comments to following email IDs:

Design Office, Kolkata : controllerdesign.ipo@nic.in

Controller General of Patents, Designs and Trademarks

Design Application Details

Application Number:

383383-001

Cbr Number:

204429

Cbr Date:

08/04/2023 21:33:55

Applicant Name:

1. Dr. Dinkar Jagannath Gaikwad 2. Dr. Sagar Maitra 3. Dr. Nitin Baban Ubale
4. Dr. Prajjal Dey 5. Dr. Apurba Pal 6. Dr. Prafulla Kumar Panda
7. Ms. Vadaga Dhana Sri

Design Application Status

Application Status:

Design Accepted and Published, Journal No is 19/2024 and Journal Date is 10/05/2024

[Back \(/DesignApplicationStatus/\)](#)

Disclaimer: Application status is available for the application filed on or after 1st April 2009 with application no 222230. The information under " Design Application Status" is dynamically retrieved and is under testing, therefore the information retrieved by this system is not valid for any legal proceedings under the Design Act 2000. In case of any discrepancy you may contact the appropriate Patent Office or send your comments to following email IDs:

Design Office, Kolkata : controllerdesign.ipo@nic.in

Controller General of Patents, Designs and Trademarks

Design Application Details

Application Number:

384323-001

Cbr Number:

204927

Cbr Date:

19/04/2023 20:12:26

Applicant Name:

1. Dr. Dinkar Jagannath Gaikwad
2. Dr. Sagar Maitra
3. Dr. Prajjal Dey
4. Dr. Nitin Baban Ubale
5. Dr. Nihal R
6. Dr. Prafulla Kumar Panda
7. Mr. Subash Chandra Munda

Design Application Status

Application Status:

Design Accepted and Published, Journal No is 15/2024 and Journal Date is 12/04/2024

[Back \(/DesignApplicationStatus/\)](#)

Disclaimer: Application status is available for the application filed on or after 1st April 2009 with application no 222230. The information under " Design Application Status" is dynamically retrieved and is under testing, therefore the information retrieved by this system is not valid for any legal proceedings under the Design Act 2000. In case of any discrepancy you may contact the appropriate Patent Office or send your comments to following email IDs:

Design Office, Kolkata : controllerdesign.ipo@nic.in

Controller General of Patents, Designs and Trademarks

Design Application Details

Application Number:

352425-001

Cbr Number:

209382

Cbr Date:

30/10/2021 22:11:17

Applicant Name:

1. Dr.R.Balamurugan 2. Mr.T.Ch. Anil Kumar 3. Dr.Rabinarayan Satpathy
4. Dr.Chandra Sekhar Dash

Design Application Status

Application Status:

Design Accepted and Published, Journal No is 19/2024 and Journal Date is 10/05/2024

[Back \(/DesignApplicationStatus/\)](/DesignApplicationStatus/)

Disclaimer: Application status is available for the application filed on or after 1st April 2009 with application no 222230. The information under " Design Application Status" is dynamically retrieved and is under testing, therefore the information retrieved by this system is not valid for any legal proceedings under the Design Act 2000. In case of any discrepancy you may contact the appropriate Patent Office or send your comments to following email IDs:

Design Office, Kolkata : controllerdesign.ipo@nic.in

Controller General of Patents, Designs and Trademarks

Design Application Details

Application Number:

400479-001

Cbr Number:

214776

Cbr Date:

22/11/2023 20:54:37

Applicant Name:

1. Mr. Anil Kumar Jonnalagadda
2. Dr. Vangapandu Thriveni
3. Prof. N. Venugopala Rao
4. Dr. Korla Harshavardhan
5. Dr. Parle Kalyan Chakravarthy
6. Dr. S. Bhargav Kiran
7. Dr. Goutam B. Hosamani
8. Dr. M SV Satyanarayana
9. Dr. N. Jhansirani
10. Prof. S. Eswara Reddy

Design Application Status

Application Status:

Design Accepted and Published, Journal No is 03/2024 and Journal Date is 19/01/2024

[Back \(/DesignApplicationStatus/\)](#)

Disclaimer: Application status is available for the application filed on or after 1st April 2009 with application no 222230. The information under " Design Application Status" is dynamically retrieved and is under testing, therefore the information retrieved by this system is not valid for any legal proceedings under the Design Act 2000. In case of any discrepancy you may contact the appropriate Patent Office or send your comments to following email IDs:

Design Office, Kolkata : controllerdesign.ipo@nic.in

Controller General of Patents, Designs and Trademarks

Design Application Details

Application Number:

400461-001

Cbr Number:

214764

Cbr Date:

22/11/2023 18:12:50

Applicant Name:

- | | | |
|----------------------------|---------------------------|-------------------------|
| 1. Dr. Tikendra Nath Verma | 2. Dr. Upendra Rajak | 3. Dr. Manoj Panchal |
| 4. Dr. B. Sidda Reddy | 5. Dr. Syed Altaf Hussain | 6. Dr. K. Sudha Madhuri |
| 7. Ms. Sima Das | 8. Dr. Nimay Chandra Giri | |

Design Application Status

Application Status:

Design Accepted and Published, Journal No is 05/2024 and Journal Date is 02/02/2024

[Back \(/DesignApplicationStatus/\)](#)

Disclaimer: Application status is available for the application filed on or after 1st April 2009 with application no 222230. The information under " Design Application Status" is dynamically retrieved and is under testing, therefore the information retrieved by this system is not valid for any legal proceedings under the Design Act 2000. In case of any discrepancy you may contact the appropriate Patent Office or send your comments to following email IDs:

Design Office, Kolkata : controllerdesign.ipo@nic.in

Controller General of Patents, Designs and Trademarks

Design Application Details

Application Number:

403507-001

Cbr Number:

216665

Cbr Date:

30/12/2023 13:44:49

Applicant Name:

- | | | |
|------------------------|---------------------|---------------------------|
| 1. Dr. Meenakshi Attri | 2. Dr. Rubby Sandhu | 3. Mr. Sachin |
| 4. Dr. Mohammad Amir | 5. Mr. Vijay Kumar | 6. Mr. Parkash Verma |
| 7. Mr. Harsh Jyani | 8. Mr. Akshit | 9. Dr. Nimay Chandra Giri |

Design Application Status

Application Status:

Design Accepted and Published, Journal No is 06/2024 and Journal Date is 09/02/2024

[Back \(/DesignApplicationStatus/\)](#)

Disclaimer: Application status is available for the application filed on or after 1st April 2009 with application no 222230. The information under " Design Application Status" is dynamically retrieved and is under testing, therefore the information retrieved by this system is not valid for any legal proceedings under the Design Act 2000. In case of any discrepancy you may contact the appropriate Patent Office or send your comments to following email IDs:

Design Office, Kolkata : controllerdesign.ipo@nic.in

Controller General of Patents, Designs and Trademarks

Design Application Details

Application Number:

402283-001

Cbr Number:

215964

Cbr Date:

15/12/2023 22:25:55

Applicant Name:

1. Dr. Manoj Panchal
2. Dr. K.Sudha Madhuri
3. Dr. Syed Altaf Hussain
4. Dr. Bathini Sidda Reddy
5. Dr. V. Chandra Sekhar
6. Dr. K. Thirupathi Reddy
7. Dr. Upendra Rajak
8. Dr. Nimay Chandra Giri
9. Dr. M.D. Alamgir
10. Dr. Rubby Sandhu

Design Application Status

Application Status:

Design Accepted and Published, Journal No is 07/2024 and Journal Date is 16/02/2024

[Back \(/DesignApplicationStatus/\)](#)

Disclaimer: Application status is available for the application filed on or after 1st April 2009 with application no 222230. The information under " Design Application Status" is dynamically retrieved and is under testing, therefore the information retrieved by this system is not valid for any legal proceedings under the Design Act 2000. In case of any discrepancy you may contact the appropriate Patent Office or send your comments to following email IDs:

Design Office, Kolkata : controllerdesign.ipo@nic.in

Controller General of Patents, Designs and Trademarks

Design Application Details

Application Number:

383315-001

Cbr Number:

204384

Cbr Date:

07/04/2023 13:09:37

Applicant Name:

1. Ms. Sima Das
2. Dr. Tanmay Kumar Behera
3. Ms. Camellia Ray
4. Prof. Rabindranath Sahu
5. Dr. Prangya Parimita Pradhan
6. Prof. Subhrashree Pritichhanda
7. Dr. Aditi Chatterjee
8. Dr. Sasmita Behera
9. Dr. Nimay Chandra Giri

Design Application Status

Application Status:

Design Accepted and Published, Journal No is 23/2024 and Journal Date is 07/06/2024

[Back \(/DesignApplicationStatus/\)](#)

Disclaimer: Application status is available for the application filed on or after 1st April 2009 with application no 222230. The information under " Design Application Status" is dynamically retrieved and is under testing, therefore the information retrieved by this system is not valid for any legal proceedings under the Design Act 2000. In case of any discrepancy you may contact the appropriate Patent Office or send your comments to following email IDs:

Design Office, Kolkata : controllerdesign.ipo@nic.in

Controller General of Patents, Designs and Trademarks

Design Application Details

Application Number:

411759-001

Cbr Number:

205135

Cbr Date:

27/03/2024 21:21:09

Applicant Name:

1. Dr. NIMAY CHANDRA GIRI,
2. Dr. UPALI APARAJITA DASH,
3. Dr. SASMITA PAHADSINGH,
4. Dr. TEJASWINI KAR,
5. Mrs. MANJUSHA BEHERA,
6. Mrs. TAPASWINI PATTNAIK,
7. Dr. ARUN AGARWAL

Design Application Status

Application Status:

Design Accepted and Published, Journal No is 23/2024 and Journal Date is 07/06/2024

[Back \(/DesignApplicationStatus/\)](#)

Disclaimer: Application status is available for the application filed on or after 1st April 2009 with application no 222230. The information under " Design Application Status" is dynamically retrieved and is under testing, therefore the information retrieved by this system is not valid for any legal proceedings under the Design Act 2000. In case of any discrepancy you may contact the appropriate Patent Office or send your comments to following email IDs:

Design Office, Kolkata : controllerdesign.ipo@nic.in

Controller General of Patents, Designs and Trademarks



ORIGINAL
क्रम सं/ Serial No. : 173802



पेटेंट कार्यालय, भारत सरकार | The Patent Office, Government Of India

डिजाइन के पंजीकरण का प्रमाण पत्र | Certificate of Registration of Design

डिजाइन सं. / Design No. : 414067-001

तारीख / Date : 18/04/2024

पारस्परिकता तारीख / Reciprocity Date* :

देश / Country :

प्रमाणित किया जाता है कि संलग्न प्रति में वर्णित डिजाइन जो **SMART HORTICULTURAL SPREADER MACHINE** से संबंधित है, का पंजीकरण, श्रेणी 15-99 में 1.Centurion University Of Technology And Management 2. Dr. Swapnil 3.Dr. Digvijay Singh 4.Dr. Sumit Pal 5.Dr. Sudheer Kumar Yadav 6.Dr. Smita Gupta 7.Dr. Aniketa Horo 8.Dr. Subhajit Pal 9.Mr. Buddhisatya Dowarah 10.Dr. Vangapandu Thriveni 11.Prof. S. Eswara Reddy के नाम में उपर्युक्त संख्या और तारीख में कर लिया गया है।

Certified that the design of which a copy is annexed hereto has been registered as of the number and date given above in class 15-99 in respect of the application of such design to **SMART HORTICULTURAL SPREADER MACHINE** in the name of 1.Centurion University Of Technology And Management 2. Dr. Swapnil 3.Dr. Digvijay Singh 4.Dr. Sumit Pal 5.Dr. Sudheer Kumar Yadav 6.Dr. Smita Gupta 7.Dr. Aniketa Horo 8.Dr. Subhajit Pal 9.Mr. Buddhisatya Dowarah 10.Dr. Vangapandu Thriveni 11.Prof. S. Eswara Reddy.

डिजाइन अधिनियम, 2000 तथा डिजाइन नियम, 2001 के अधधीन प्रावधानों के अनुसरण में।

In pursuance of and subject to the provisions of the Designs Act, 2000 and the Designs Rules, 2001.



(Signature)
कुमार की पंडित

महानियंत्रक पेटेंट, डिजाइन और व्यापार चिह्न
Controller General of Patents, Designs and Trade Marks

जारी करने की तिथि : 04/07/2024
Date of Issue

*पारस्परिकता तारीख (यदि कोई हो) जिसकी अनुमति दी गई है तथा देश का नाम। डिजाइन का स्वत्वाधिकार पंजीकरण की तारीख से दस वर्षों के लिए होगा जिसका विस्तार, अधिनियम एवं नियम के निबंधनों के अधीन, पाँच वर्षों की अतिरिक्त अवधि के लिए किया जा सकेगा। इस प्रमाण पत्र का उपयोग विधिक कार्यवाहियों अथवा विदेश में पंजीकरण प्राप्त करने के लिए नहीं हो सकता है।
The reciprocity date (if any) which has been allowed and the name of the country. Copyright in the design will subsist for ten years from the date of Registration, and may under the terms of the Act and Rules, be extended for a further period of five years. This Certificate is not for use in legal proceedings or for obtaining registration abroad.



ORIGINAL
क्रम सं/ Serial No. : 181125



पेटेंट कार्यालय, भारत सरकार | The Patent Office, Government Of India

डिजाइन के पंजीकरण का प्रमाण पत्र | Certificate of Registration of Design

डिजाइन सं. / Design No. : 428395-001

तारीख / Date : 27/08/2024

पारस्परिकता तारीख / Reciprocity Date* :

देश / Country :

प्रमाणित किया जाता है कि संलग्न प्रति में वर्णित डिजाइन जो **BRAIN TUMOR DETECTION DEVICE** से संबंधित है, का पंजीकरण, श्रेणी 24-01 में 1.Centurion University Of Technology & Management (Cutm) 2. Mrs. Jyoshna Rani Dash के नाम में उपर्युक्त संख्या और तारीख में कर लिया गया है।

Certified that the design of which a copy is annexed hereto has been registered as of the number and date given above in class 24-01 in respect of the application of such design to **BRAIN TUMOR DETECTION DEVICE** in the name of 1.Centurion University Of Technology & Management (Cutm) 2. Mrs. Jyoshna Rani Dash.

डिजाइन अधिनियम, 2000 तथा डिजाइन नियम, 2001 के अधधीन प्रावधानों के अनुसरण में।

In pursuance of and subject to the provisions of the Designs Act, 2000 and the Designs Rules, 2001.



(Signature)
कुनात की पंडित

महानियंत्रक पेटेंट, डिजाइन और व्यापार चिह्न
Controller General of Patents, Designs and Trade Marks

जारी करने की तिथि : 25/09/2024
Date of Issue

*पारस्परिकता तारीख (यदि कोई हो) जिसकी अनुमति दी गई है तथा देश का नाम। डिजाइन का स्वत्वाधिकार पंजीकरण की तारीख से दस वर्षों के लिए होगा जिसका विस्तार, अधिनियम एवं नियम के निबंधनों के अधीन, पाँच वर्षों की अतिरिक्त अवधि के लिए किया जा सकेगा। इस प्रमाण पत्र का उपयोग विधिक कार्यवाहियों अथवा विदेश में पंजीकरण प्राप्त करने के लिए नहीं हो सकता है।

The reciprocity date (if any) which has been allowed and the name of the country. Copyright in the design will subsist for ten years from the date of Registration, and may under the terms of the Act and Rules, be extended for a further period of five years. This Certificate is not for use in legal proceedings or for obtaining registration abroad.



ORIGINAL
क्रम सं/ Serial No. : 182391



पेटेंट कार्यालय, भारत सरकार | The Patent Office, Government Of India

डिजाइन के पंजीकरण का प्रमाण पत्र | Certificate of Registration of Design

डिजाइन सं. / Design No. : 428401-001

तारीख / Date : 27/08/2024

पारस्परिकता तारीख / Reciprocity Date* :

देश / Country :

प्रमाणित किया जाता है कि संलग्न प्रति में वर्णित डिजाइन जो **PORTABLE HAIR HEALTH ANALYZER** से संबंधित है, का पंजीकरण, श्रेणी 24-01 में 1.Centurion University Of Technology & Management (Cutm) 2. Mrs. Aradhana Panigrahi के नाम में उपर्युक्त संख्या और तारीख में कर लिया गया है।

Certified that the design of which a copy is annexed hereto has been registered as of the number and date given above in class 24-01 in respect of the application of such design to **PORTABLE HAIR HEALTH ANALYZER** in the name of 1.Centurion University Of Technology & Management (Cutm) 2. Mrs. Aradhana Panigrahi.

डिजाइन अधिनियम, 2000 तथा डिजाइन नियम, 2001 के अधधीन प्रावधानों के अनुसरण में।

In pursuance of and subject to the provisions of the Designs Act, 2000 and the Designs Rules, 2001.



(Signature)
कुनात की पंडित

महानियंत्रक पेटेंट, डिजाइन और व्यापार चिह्न
Controller General of Patents, Designs and Trade Marks

जारी करने की तिथि : 08/10/2024
Date of Issue

*पारस्परिकता तारीख (यदि कोई हो) जिसकी अनुमति दी गई है तथा देश का नाम। डिजाइन का स्वत्वाधिकार पंजीकरण की तारीख से दस वर्षों के लिए होगा जिसका विस्तार, अधिनियम एवं नियम के निबंधनों के अधीन, पाँच वर्षों की अतिरिक्त अवधि के लिए किया जा सकेगा। इस प्रमाण पत्र का उपयोग विधिक कार्यवाहियों अथवा विदेश में पंजीकरण प्राप्त करने के लिए नहीं हो सकता है।
The reciprocity date (if any) which has been allowed and the name of the country. Copyright in the design will subsist for ten years from the date of Registration, and may under the terms of the Act and Rules, be extended for a further period of five years. This Certificate is not for use in legal proceedings or for obtaining registration abroad.



ORIGINAL
क्रम सं/ Serial No. : 183213



पेटेंट कार्यालय, भारत सरकार | The Patent Office, Government Of India

डिजाइन के पंजीकरण का प्रमाण पत्र | Certificate of Registration of Design

डिजाइन सं. / Design No. : 428414-001

तारीख / Date : 27/08/2024

पारस्परिकता तारीख / Reciprocity Date* :

देश / Country :

प्रमाणित किया जाता है कि संलग्न प्रति में वर्णित डिजाइन जो **SENSOR ENABLED VITAMIN LEVEL DIAGNOSIS DEVICE** से संबंधित है, का पंजीकरण, श्रेणी 24-01 में 1.Centurion University Of Technology & Management (Cutm) 2. Ms. Gupatnjali Sahu के नाम में उपर्युक्त संख्या और तारीख में कर लिया गया है।

Certified that the design of which a copy is annexed hereto has been registered as of the number and date given above in class 24-01 in respect of the application of such design to **SENSOR ENABLED VITAMIN LEVEL DIAGNOSIS DEVICE** in the name of 1.Centurion University Of Technology & Management (Cutm) 2. Ms. Gupatnjali Sahu.

डिजाइन अधिनियम, 2000 तथा डिजाइन नियम, 2001 के अधधीन प्रावधानों के अनुसरण में।

In pursuance of and subject to the provisions of the Designs Act, 2000 and the Designs Rules, 2001.



(Signature)
कुनात की पंडित

महानियंत्रक पेटेंट, डिजाइन और व्यापार चिह्न
Controller General of Patents, Designs and Trade Marks

जारी करने की तिथि : 24/10/2024
Date of Issue

*पारस्परिकता तारीख (यदि कोई हो) जिसकी अनुमति दी गई है तथा देश का नाम। डिजाइन का स्वत्वाधिकार पंजीकरण की तारीख से दस वर्षों के लिए होगा जिसका विस्तार, अधिनियम एवं नियम के निबंधनों के अधीन, पाँच वर्षों की अतिरिक्त अवधि के लिए किया जा सकेगा। इस प्रमाण पत्र का उपयोग विधिक कार्यवाहियों अथवा विदेश में पंजीकरण प्राप्त करने के लिए नहीं हो सकता है।
The reciprocity date (if any) which has been allowed and the name of the country. Copyright in the design will subsist for ten years from the date of Registration, and may under the terms of the Act and Rules, be extended for a further period of five years. This Certificate is not for use in legal proceedings or for obtaining registration abroad.



ORIGINAL
क्रम सं/ Serial No. : 184128



पेटेंट कार्यालय, भारत सरकार | The Patent Office, Government Of India

डिजाइन के पंजीकरण का प्रमाण पत्र | Certificate of Registration of Design

डिजाइन सं. / Design No. : 428418-001

तारीख / Date : 27/08/2024

पारस्परिकता तारीख / Reciprocity Date* : -

देश / Country : भारत

प्रमाणित किया जाता है कि संलग्न प्रति में वर्णित डिजाइन जो **PHYTOCONSTITUENT EXTRACTION DEVICE** से संबंधित है, का पंजीकरण, श्रेणी 24-01 में 1. Centurion University Of Technology & Management (Cutm) 2. Dr. Biswa Mohan Sahoo के नाम में उपर्युक्त संख्या और तारीख में कर लिया गया है।

Certified that the design of which a copy is annexed hereto has been registered as of the number and date given above in class 24-01 in respect of the application of such design to **PHYTOCONSTITUENT EXTRACTION DEVICE** in the name of 1. Centurion University Of Technology & Management (Cutm) 2. Dr. Biswa Mohan Sahoo.

डिजाइन अधिनियम, 2000 तथा डिजाइन नियम, 2001 के अधधीन प्रावधानों के अनुसरण में।

In pursuance of and subject to the provisions of the Designs Act, 2000 and the Designs Rules, 2001.

जारी करने की तिथि : 04/11/2024
Date of Issue



(Signature)
कृपाल की पंडित

महानियंत्रक पेटेंट, डिजाइन और व्यापार चिह्न
Controller General of Patents, Designs and Trade Marks

*पारस्परिकता तारीख (यदि कोई हो) जिसकी अनुमति दी गई है तथा देश का नाम। डिजाइन का स्वत्वाधिकार पंजीकरण की तारीख से दस वर्षों के लिए होगा जिसका विस्तार, अधिनियम एवं नियम के निबंधनों के अधीन, पाँच वर्षों की अतिरिक्त अवधि के लिए किया जा सकेगा। इस प्रमाण पत्र का उपयोग विधिक कार्यवाहियों अथवा विदेश में पंजीकरण प्राप्त करने के लिए नहीं हो सकता है।

The reciprocity date (if any) which has been allowed and the name of the country. Copyright in the design will subsist for ten years from the date of Registration, and may under the terms of the Act and Rules, be extended for a further period of five years. This Certificate is not for use in legal proceedings or for obtaining registration abroad.



ORIGINAL
क्रम सं/ Serial No. : 182229



पेटेंट कार्यालय, भारत सरकार | The Patent Office, Government Of India

डिजाइन के पंजीकरण का प्रमाण पत्र | Certificate of Registration of Design

डिजाइन सं. / Design No. : 428464-001

तारीख / Date : 28/08/2024

पारस्परिकता तारीख / Reciprocity Date* :

देश / Country :

प्रमाणित किया जाता है कि संलग्न प्रति में वर्णित डिजाइन जो **COLD PLATE WITH MAGNETIC STIRRER** से संबंधित है, का पंजीकरण, श्रेणी 24-01 में 1.Centurion University of Technology & Management (Cutm) 2. Mr. Satish Kanhar 3.Dr. Ashirbad Nanda के नाम में उपर्युक्त संख्या और तारीख में कर लिया गया है।

Certified that the design of which a copy is annexed hereto has been registered as of the number and date given above in class 24-01 in respect of the application of such design to **COLD PLATE WITH MAGNETIC STIRRER** in the name of 1.Centurion University Of Technology & Management (Cutm) 2. Mr. Satish Kanhar 3.Dr. Ashirbad Nanda.

डिजाइन अधिनियम, 2000 तथा डिजाइन नियम, 2001 के अधधीन प्रावधानों के अनुसरण में।

In pursuance of and subject to the provisions of the Designs Act, 2000 and the Designs Rules, 2001.

जारी करने की तिथि : 07/10/2024
Date of Issue



(Signature)
कुनात की पंडित

महानियंत्रक पेटेंट, डिजाइन और व्यापार चिह्न
Controller General of Patents, Designs and Trade Marks

*पारस्परिकता तारीख (यदि कोई हो) जिसकी अनुमति दी गई है तथा देश का नाम। डिजाइन का स्वत्वाधिकार पंजीकरण की तारीख से दस वर्षों के लिए होगा जिसका विस्तार, अधिनियम एवं नियम के निबंधनों के अधीन, पाँच वर्षों की अतिरिक्त अवधि के लिए किया जा सकेगा। इस प्रमाण पत्र का उपयोग विधिक कार्यवाहियों अथवा विदेश में पंजीकरण प्राप्त करने के लिए नहीं हो सकता है।
The reciprocity date (if any) which has been allowed and the name of the country. Copyright in the design will subsist for ten years from the date of Registration, and may under the terms of the Act and Rules, be extended for a further period of five years. This Certificate is not for use in legal proceedings or for obtaining registration abroad.



ORIGINAL
क्रम सं/ Serial No. : 183378



पेटेंट कार्यालय, भारत सरकार | The Patent Office, Government Of India

डिजाइन के पंजीकरण का प्रमाण पत्र | Certificate of Registration of Design

डिजाइन सं. / Design No. : 428467-001

तारीख / Date : 28/08/2024

पारस्परिकता तारीख / Reciprocity Date* :

देश / Country :

प्रमाणित किया जाता है कि संलग्न प्रति में वर्णित डिजाइन जो **GAMING CONSOLE DEVICE WITH EYE HEALTH MONITORING** से संबंधित है, का पंजीकरण, श्रेणी 21-01 में 1.Centurion University Of Technology & Management (Cutm) 2. Salony Sreeya Pattnaik 3.Jayeeta Dandapat के नाम में उपर्युक्त संख्या और तारीख में कर लिया गया है।

Certified that the design of which a copy is annexed hereto has been registered as of the number and date given above in class 21-01 in respect of the application of such design to **GAMING CONSOLE DEVICE WITH EYE HEALTH MONITORING** in the name of 1.Centurion University Of Technology & Management (Cutm) 2. Salony Sreeya Pattnaik 3.Jayeeta Dandapat.

डिजाइन अधिनियम, 2000 तथा डिजाइन नियम, 2001 के अधधीन प्रावधानों के अनुसरण में।

In pursuance of and subject to the provisions of the Designs Act, 2000 and the Designs Rules, 2001.

जारी करने की तिथि : 24/10/2024
Date of Issue



(Signature)
कुनात की पंडित

महानियंत्रक पेटेंट, डिजाइन और व्यापार चिह्न
Controller General of Patents, Designs and Trade Marks

*पारस्परिकता तारीख (यदि कोई हो) जिसकी अनुमति दी गई है तथा देश का नाम। डिजाइन का स्वत्वाधिकार पंजीकरण की तारीख से दस वर्षों के लिए होगा जिसका विस्तार, अधिनियम एवं नियम के निबंधनों के अधीन, पाँच वर्षों की अतिरिक्त अवधि के लिए किया जा सकेगा। इस प्रमाण पत्र का उपयोग विधिक कार्यवाहियों अथवा विदेश में पंजीकरण प्राप्त करने के लिए नहीं हो सकता है।

The reciprocity date (if any) which has been allowed and the name of the country. Copyright in the design will subsist for ten years from the date of Registration, and may under the terms of the Act and Rules, be extended for a further period of five years. This Certificate is not for use in legal proceedings or for obtaining registration abroad.



ORIGINAL
क्रम सं/ Serial No. : 183214



पेटेंट कार्यालय, भारत सरकार | The Patent Office, Government Of India

डिजाइन के पंजीकरण का प्रमाण पत्र | Certificate of Registration of Design

डिजाइन सं. / Design No. : 428492-001

तारीख / Date : 28/08/2024

पारस्परिकता तारीख / Reciprocity Date* :

देश / Country :

प्रमाणित किया जाता है कि संलग्न प्रति में वर्णित डिजाइन जो **BIO-SENSOR INTEGRATED PHYSIOTHERAPY INSTRUMENT** से संबंधित है, का पंजीकरण, श्रेणी 24-01 में 1.Centurion University Of Technology & Management (Cutm) 2. Dr. Grandhi Sri Kavya 3.Dr. Pamidimarri Dattasai 4.Dr. Soumya Saswati Panigrahi के नाम में उपर्युक्त संख्या और तारीख में कर लिया गया है।

Certified that the design of which a copy is annexed hereto has been registered as of the number and date given above in class 24-01 in respect of the application of such design to **BIO-SENSOR INTEGRATED PHYSIOTHERAPY INSTRUMENT** in the name of 1.Centurion University Of Technology & Management (Cutm) 2. Dr. Grandhi Sri Kavya 3.Dr. Pamidimarri Dattasai 4.Dr. Soumya Saswati Panigrahi.

डिजाइन अधिनियम, 2000 तथा डिजाइन नियम, 2001 के अधधीन प्रावधानों के अनुसरण में।

In pursuance of and subject to the provisions of the Designs Act, 2000 and the Designs Rules, 2001.

जारी करने की तिथि : 24/10/2024
Date of Issue



कुमार की अंसि
Signature

महानियंत्रक पेटेंट, डिजाइन और व्यापार चिह्न
Controller General of Patents, Designs and Trade Marks

*पारस्परिकता तारीख (यदि कोई हो) जिसकी अनुमति दी गई है तथा देश का नाम। डिजाइन का स्वत्वाधिकार पंजीकरण की तारीख से दस वर्षों के लिए होगा जिसका विस्तार, अधिनियम एवं नियम के निबंधनों के अधीन, पाँच वर्षों की अतिरिक्त अवधि के लिए किया जा सकेगा। इस प्रमाण पत्र का उपयोग विधिक कार्यवाहियों अथवा विदेश में पंजीकरण प्राप्त करने के लिए नहीं हो सकता है।
The reciprocity date (if any) which has been allowed and the name of the country. Copyright in the design will subsist for ten years from the date of Registration, and may under the terms of the Act and Rules, be extended for a further period of five years. This Certificate is not for use in legal proceedings or for obtaining registration abroad.



ORIGINAL
क्रम सं/ Serial No. : 185335



पेटेंट कार्यालय, भारत सरकार | The Patent Office, Government Of India

डिजाइन के पंजीकरण का प्रमाण पत्र | Certificate of Registration of Design

डिजाइन सं. / Design No. : 428565-001

तारीख / Date : 28/08/2024

पारस्परिकता तारीख / Reciprocity Date* :

देश / Country :

प्रमाणित किया जाता है कि संलग्न प्रति में वर्णित डिजाइन जो **BATTERY MANAGEMENT SYSTEM FOR E-CYCLE** से संबंधित है, का पंजीकरण, श्रेणी 13-02 में 1.Centurion University Of Technology & Management (Cutm) 2. Smitanjali Rout 3.Sudhansu Kumar Samal के नाम में उपर्युक्त संख्या और तारीख में कर लिया गया है।

Certified that the design of which a copy is annexed hereto has been registered as of the number and date given above in class 13-02 in respect of the application of such design to **BATTERY MANAGEMENT SYSTEM FOR E-CYCLE** in the name of 1.Centurion University Of Technology & Management (Cutm) 2. Smitanjali Rout 3.Sudhansu Kumar Samal.

डिजाइन अधिनियम, 2000 तथा डिजाइन नियम, 2001 के अधधीन प्रावधानों के अनुसरण में।

In pursuance of and subject to the provisions of the Designs Act, 2000 and the Designs Rules, 2001.

जारी करने की तिथि : 27/11/2024
Date of Issue



(Signature)
कुमार की पंडित

महानियंत्रक पेटेंट, डिजाइन और व्यापार चिह्न
Controller General of Patents, Designs and Trade Marks

*पारस्परिकता तारीख (यदि कोई हो) जिसकी अनुमति दी गई है तथा देश का नाम। डिजाइन का स्वत्वाधिकार पंजीकरण की तारीख से दस वर्षों के लिए होगा जिसका विस्तार, अधिनियम एवं नियम के निबंधनों के अधीन, पाँच वर्षों की अतिरिक्त अवधि के लिए किया जा सकेगा। इस प्रमाण पत्र का उपयोग विधिक कार्यवाहियों अथवा विदेश में पंजीकरण प्राप्त करने के लिए नहीं हो सकता है।
The reciprocity date (if any) which has been allowed and the name of the country. Copyright in the design will subsist for ten years from the date of Registration, and may under the terms of the Act and Rules, be extended for a further period of five years. This Certificate is not for use in legal proceedings or for obtaining registration abroad.



ORIGINAL
क्रम सं/ Serial No. : 185404



पेटेंट कार्यालय, भारत सरकार | The Patent Office, Government Of India

डिजाइन के पंजीकरण का प्रमाण पत्र | Certificate of Registration of Design

डिजाइन सं. / Design No. : 431031-001

तारीख / Date : 19/09/2024

पारस्परिकता तारीख / Reciprocity Date* :

देश / Country :

प्रमाणित किया जाता है कि संलग्न प्रति में वर्णित डिजाइन जो **PORTABLE BLOOD GAS ANALYZER** से संबंधित है, का पंजीकरण, श्रेणी 24-01 में 1.Centurion University Of Technology & Management (Cutm) 2. Mrs. Rupali Rupasmita Rout के नाम में उपर्युक्त संख्या और तारीख में कर लिया गया है।

Certified that the design of which a copy is annexed hereto has been registered as of the number and date given above in class 24-01 in respect of the application of such design to **PORTABLE BLOOD GAS ANALYZER** in the name of 1.Centurion University Of Technology & Management (Cutm) 2. Mrs. Rupali Rupasmita Rout.

डिजाइन अधिनियम, 2000 तथा डिजाइन नियम, 2001 के अधधीन प्रावधानों के अनुसरण में।

In pursuance of and subject to the provisions of the Designs Act, 2000 and the Designs Rules, 2001.



[Signature]
कुनात की पंडित

महानियंत्रक पेटेंट, डिजाइन और व्यापार चिह्न
Controller General of Patents, Designs and Trade Marks

जारी करने की तिथि : 27/11/2024
Date of Issue

*पारस्परिकता तारीख (यदि कोई हो) जिसकी अनुमति दी गई है तथा देश का नाम। डिजाइन का स्वत्वाधिकार पंजीकरण की तारीख से दस वर्षों के लिए होगा जिसका विस्तार, अधिनियम एवं नियम के निबंधनों के अधीन, पाँच वर्षों की अतिरिक्त अवधि के लिए किया जा सकेगा। इस प्रमाण पत्र का उपयोग विधिक कार्यवाहियों अथवा विदेश में पंजीकरण प्राप्त करने के लिए नहीं हो सकता है।

The reciprocity date (if any) which has been allowed and the name of the country. Copyright in the design will subsist for ten years from the date of Registration, and may under the terms of the Act and Rules, be extended for a further period of five years. This Certificate is not for use in legal proceedings or for obtaining registration abroad.



ORIGINAL
क्रम सं/ Serial No. : 185074



पेटेंट कार्यालय, भारत सरकार | The Patent Office, Government Of India

डिजाइन के पंजीकरण का प्रमाण पत्र | Certificate of Registration of Design

डिजाइन सं. / Design No. : 431033-001

तारीख / Date : 19/09/2024

पारस्परिकता तारीख / Reciprocity Date* :

देश / Country :

प्रमाणित किया जाता है कि संलग्न प्रति में वर्णित डिजाइन जो **HERBAL OIL INFUSED BELT FOR ARTHRITIS CURE** से संबंधित है, का पंजीकरण, श्रेणी 24-04 में 1.Centurion University Of Technology & Management (Cutm) 2. Ms. Sucharita Babu के नाम में उपर्युक्त संख्या और तारीख में कर लिया गया है।

Certified that the design of which a copy is annexed hereto has been registered as of the number and date given above in class 24-04 in respect of the application of such design to **HERBAL OIL INFUSED BELT FOR ARTHRITIS CURE** in the name of 1.Centurion University Of Technology & Management (Cutm) 2. Ms. Sucharita Babu.

डिजाइन अधिनियम, 2000 तथा डिजाइन नियम, 2001 के अध्याधीन प्रावधानों के अनुसरण में।

In pursuance of and subject to the provisions of the Designs Act, 2000 and the Designs Rules, 2001.

जारी करने की तिथि : 20/11/2024
Date of Issue



[Signature]
कुशांत की अंसि

महानियंत्रक पेटेंट, डिजाइन और व्यापार चिह्न
Controller General of Patents, Designs and Trade Marks

*पारस्परिकता तारीख (यदि कोई हो) जिसकी अनुमति दी गई है तथा देश का नाम। डिजाइन का स्वत्वाधिकार पंजीकरण की तारीख से दस वर्षों के लिए होगा जिसका विस्तार, अधिनियम एवं नियम के निबंधनों के अधीन, पाँच वर्षों की अतिरिक्त अवधि के लिए किया जा सकेगा। इस प्रमाण पत्र का उपयोग विधिक कार्यवाहियों अथवा विदेश में पंजीकरण प्राप्त करने के लिए नहीं हो सकता है।

The reciprocity date (if any) which has been allowed and the name of the country. Copyright in the design will subsist for ten years from the date of Registration, and may under the terms of the Act and Rules, be extended for a further period of five years. This Certificate is not for use in legal proceedings or for obtaining registration abroad.